

M2-1030

M2-1031

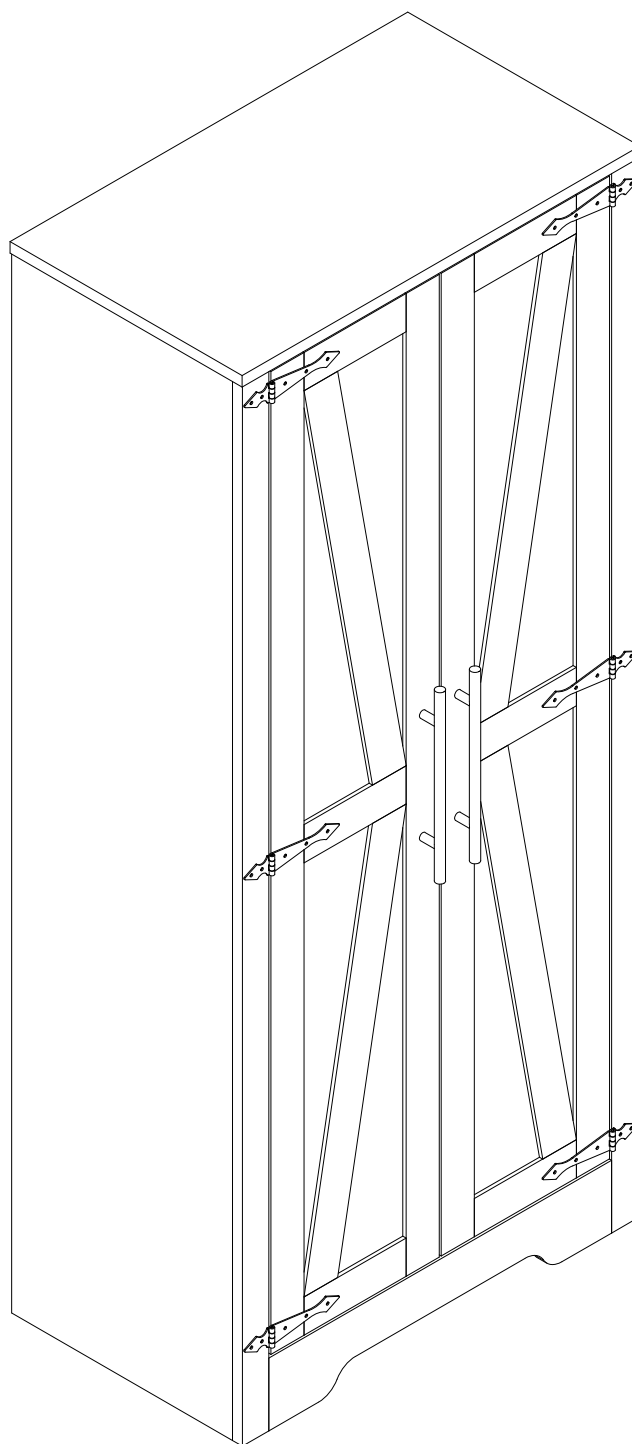

# ASSEMBLY INSTRUCTIONS

# NOTICE

IMPORTANT, RETAIN FOR FUTURE REFERENCE: READ CAREFULLY  
WICHTIG, FÜR SPÄTERE NACHSCHLAGE AUFBEWAHREN: SORGFÄLTIG LESEN  
IMPORTANTE, GUARDAR PARA REFERENCIA FUTURA: LEER ATENTAMENTE  
IMPORTANTE, CONSERVARE PER RIFERIMENTI FUTURI: LEGGERE ATTENTAMENTE  
IMPORTANT, À CONSERVER POUR RÉFÉRENCE FUTURE : LIRE ATTENTIVEMENT

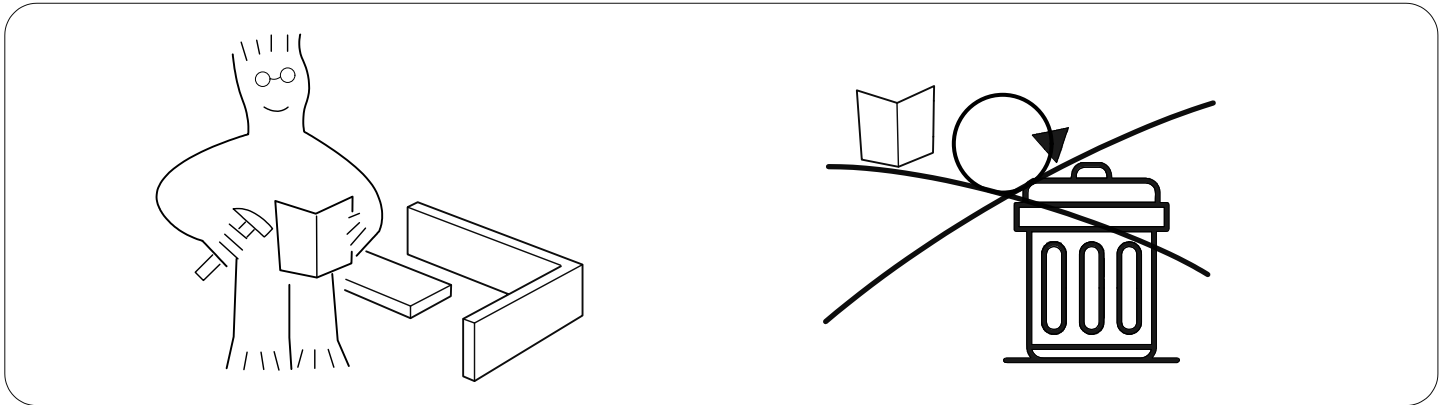

Assemble on a flat, clean and soft surface.  
Auf einer flachen, sauberen und weichen Oberfläche zusammenbauen.  
Assembler sur une surface plate, propre et douce.  
Assemblare su una superficie piatta, pulita e morbida.  
Ensamblar sobre una superficie plana, limpia y suave.

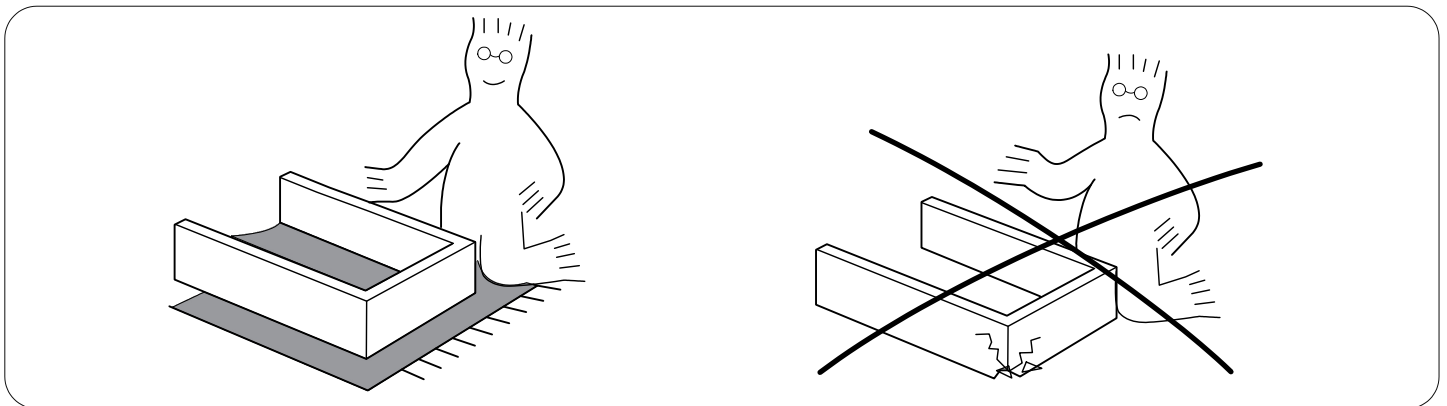

Professional installation is highly recommended.  
Eine professionelle Installation wird dringend empfohlen.  
Une installation professionnelle est fortement recommandée.  
Si raccomanda vivamente l'installazione professionale.  
Se recomienda altamente la instalación profesional.



Periodically Check That All Components Are Tightly Secured.  
Überprüfen Sie Regelmäßig, Dass Alle Komponenten Fest Gesichert Sind.  
Vérifiez Périodiquement Que Tous Les Composants Sont Bien Fixés.  
Controllare Periodicamente Che Tutti I Componenti Siano Ben Fissati.  
Verifique Periódicamente Que Todos Los Componentes Estén Bien Asegurados.



It is recommended that multiple people assemble this product.

Es wird empfohlen, dass mehrere Personen dieses Produkt zusammenbauen.

Il est recommandé que plusieurs personnes assemblent ce produit.

Si raccomanda che più persone assemblino questo prodotto.

Se recomienda que varias personas ensamblen este producto.

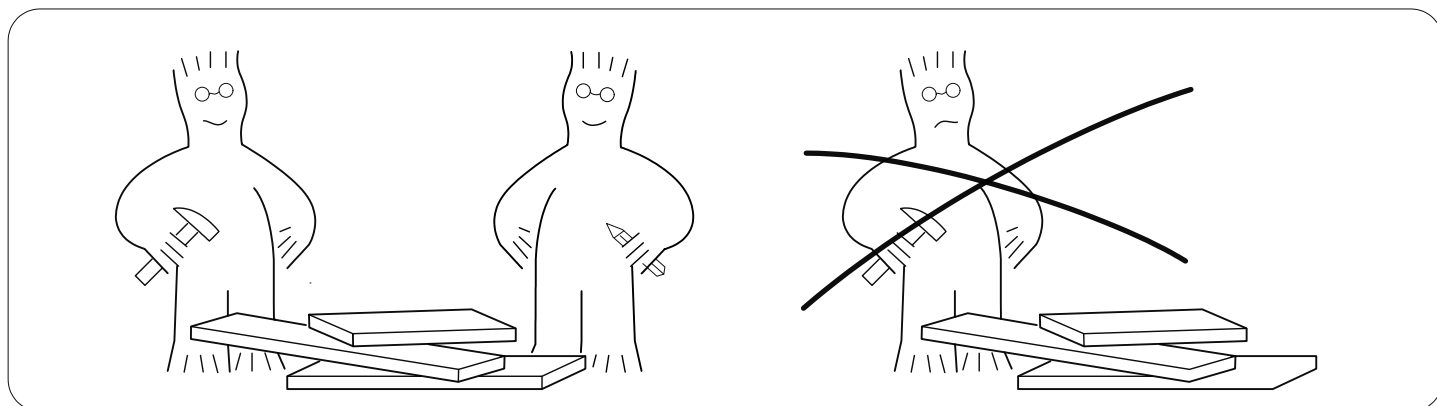

Serious or fatal crushing injuries can occur from furniture tip-over. Always secure this furniture to the wall using tip-over restraints.

Schwere oder tödliche Quetschverletzungen können durch das Umkippen von Möbeln verursacht werden. Sichern Sie diese Möbel immer mit Kipp-Sicherungen an der Wand.

Des blessures graves ou mortelles par écrasement peuvent survenir en cas de basculement de meubles. Fixez toujours ces meubles au mur à l'aide de dispositifs anti-basculement.

Lesioni gravi o mortali da schiacciamento possono verificarsi a causa del ribaltamento dei mobili. Fissare sempre questi mobili alla parete utilizzando i sistemi di blocco anti-ribaltamento.

Pueden ocurrir lesiones graves o fatales por aplastamiento debido al volcamiento de muebles. Siempre asegure este mueble a la pared utilizando dispositivos anti-vuelco.

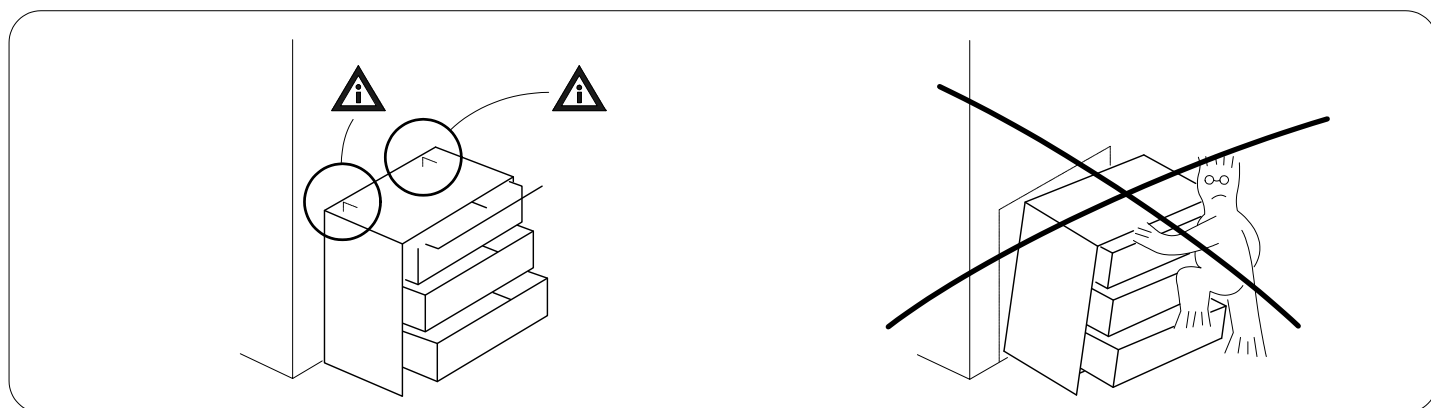

Please have the following auxiliary tools ready:

Bitte haben Sie die folgenden Hilfswerkzeuge bereit:







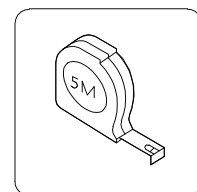
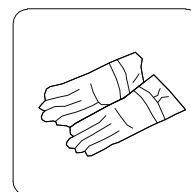
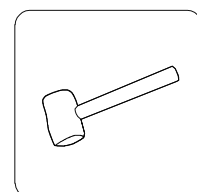
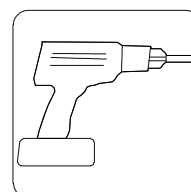



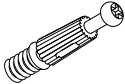

Veuillez avoir les outils auxiliaires suivants à portée de main:

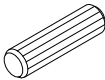
Si prega di avere pronti i seguenti strumenti ausiliari:

Por favor, tenga listos las siguientes herramientas auxiliares:

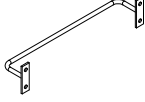
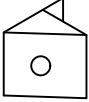
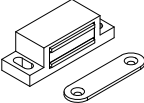
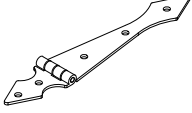
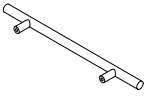

# PARTS

Item no. Nr. N° d'article Artículo No.	Reference Image Referenzbild Image de référence Immagine di riferimento Imagen de referencia	Qty. Menge Qté. Qtà Cant.	Item no. Nr. N° d'article Artículo No.	Reference Image Referenzbild Image de référence Immagine di riferimento Imagen de referencia	Qty. Menge Qté. Qtà Cant.
(A)	 M6*36mm	X52	(L)	 M5x38mm	X2
(B)	 Ø15*9.2mm	X52	(M)	 Ø8x40mm	X2
(C)	 Ø8*30mm	X36	(N)	 65x32x15	X2
(D)	 M3.5*16mm	X46	(O)	 M3x12mm	X2
(E)	 M4*16mm	X12	(P)	 Ø20mm	X16
(F)	 M3.5*14mm	X16	(Q)		X3
(G)	 M6*10mm	X16			
(H)		X4			
(I)		X6			
(J)		X2			
(K)	 M4*20mm	X4			

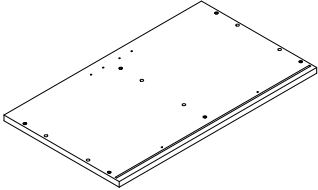
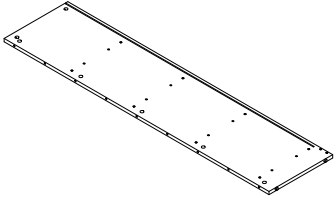
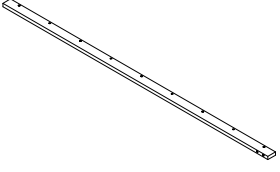
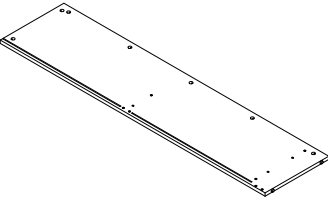
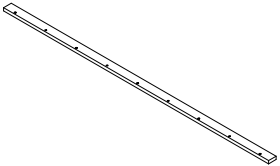
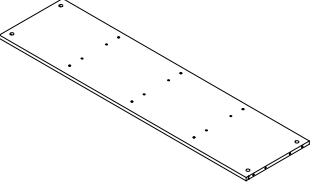
Item no. Nr. N° d'article Artículo No.	Reference Image Referenzbild Image de référence Immagine di riferimento Imagen de referencia	Qty. Menge Qté. Qtà Cant.
1		X1
2		X1
3		X1
4		X1
5		X1
6		X1

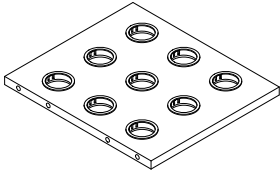
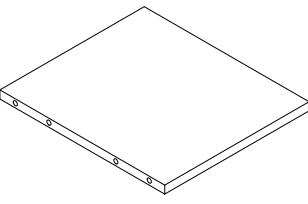
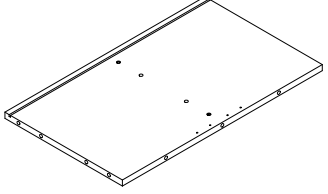
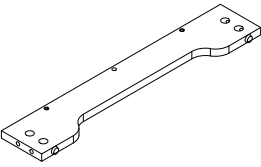
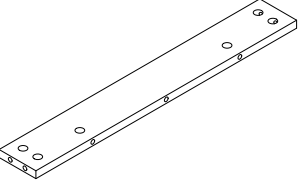
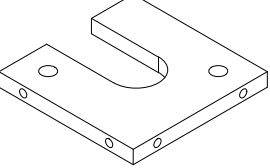
Item no. Nr. N° d'article Artículo No.	Reference Image Referenzbild Image de référence Immagine di riferimento Imagen de referencia	Qty. Menge Qté. Qtà Cant.
7		X1
8		X2
9		X1
10		X1
11		X1
12		X1

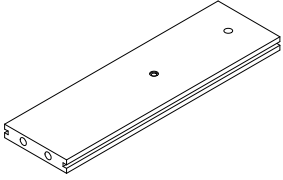
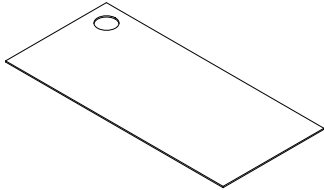
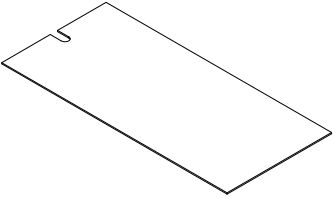
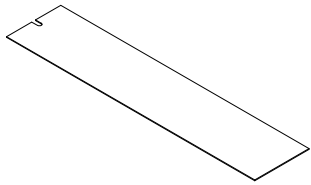
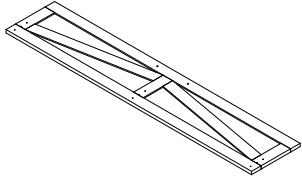
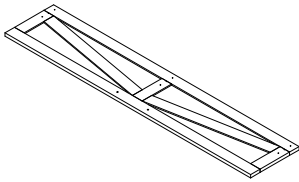
Item no. Nr. N° d'article Artículo No.	Reference Image Referenzbild Image de référence Immagine di riferimento Imagen de referencia	Qty. Menge Qté. Qtà Cant.
13		X1
14		X1
15		X1
16		X1
17		X3
18		X1

# Explosion Diagram

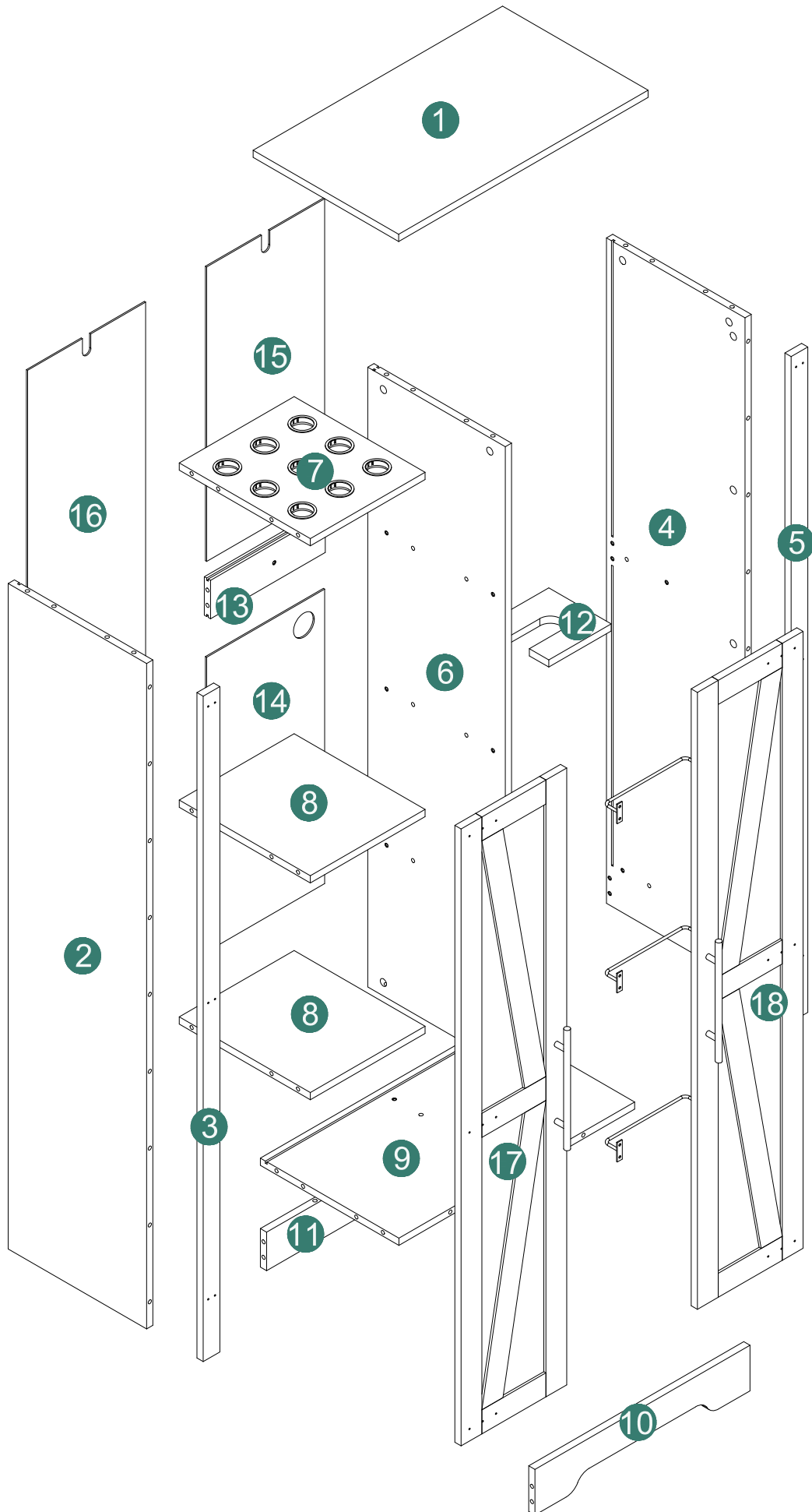

# ASSEMBLY

1

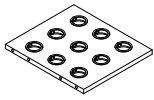

⑦1pc

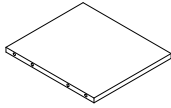

⑧2pcs

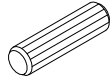

Ⓒ12pcs

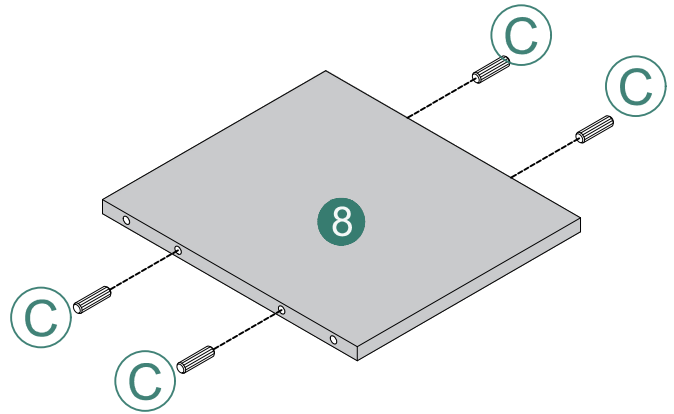
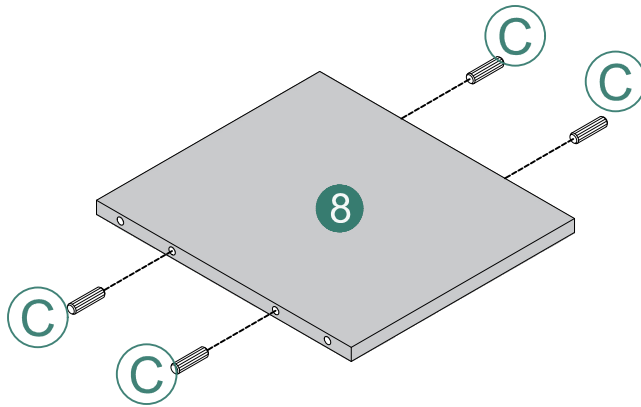
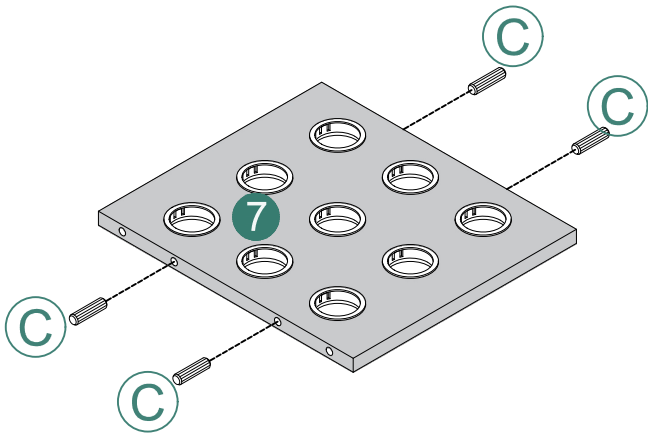

2

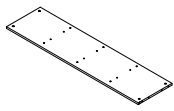

⑥1pc

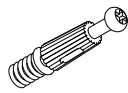

Ⓐ8pcs

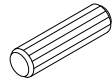

Ⓒ4pcs

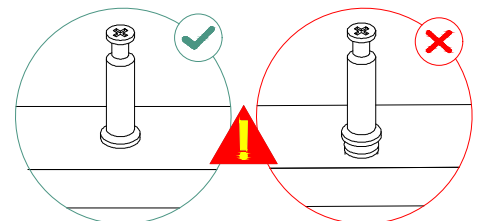
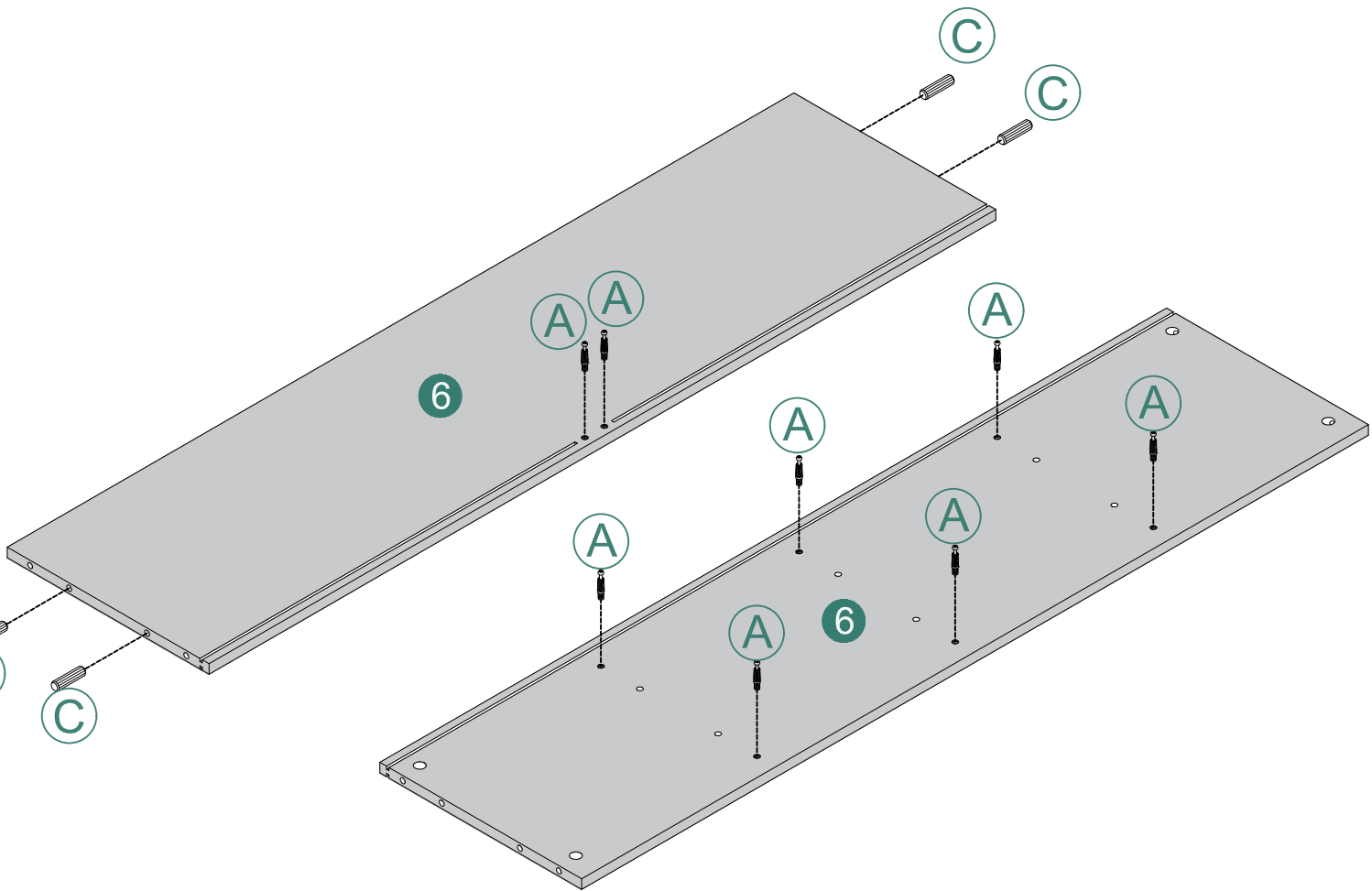

3



(B) 6pcs

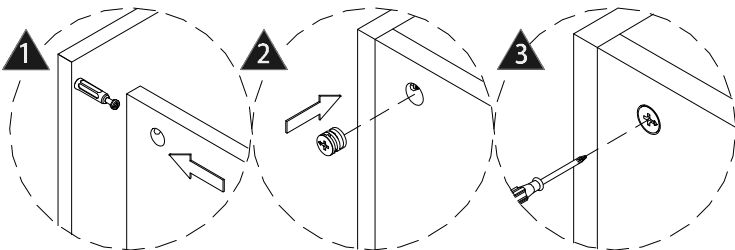
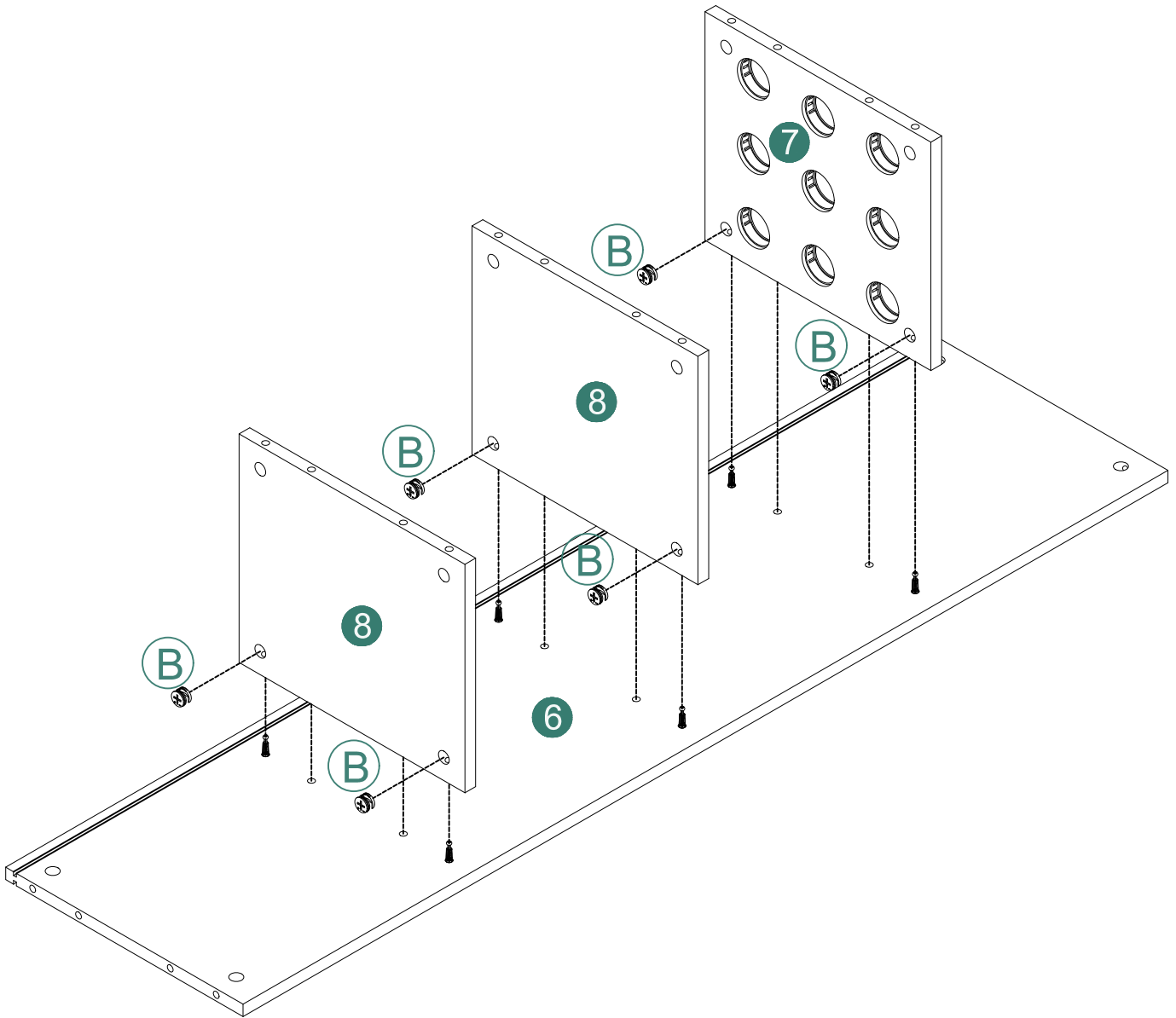

# 4

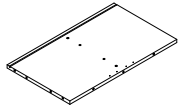

⑨ 1pc

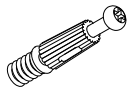

Ⓐ 4pcs

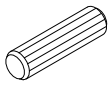

Ⓒ 4pcs



Ⓓ 4pcs

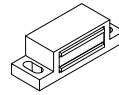

Ⓗ 2pcs

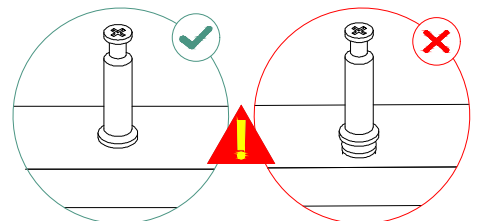
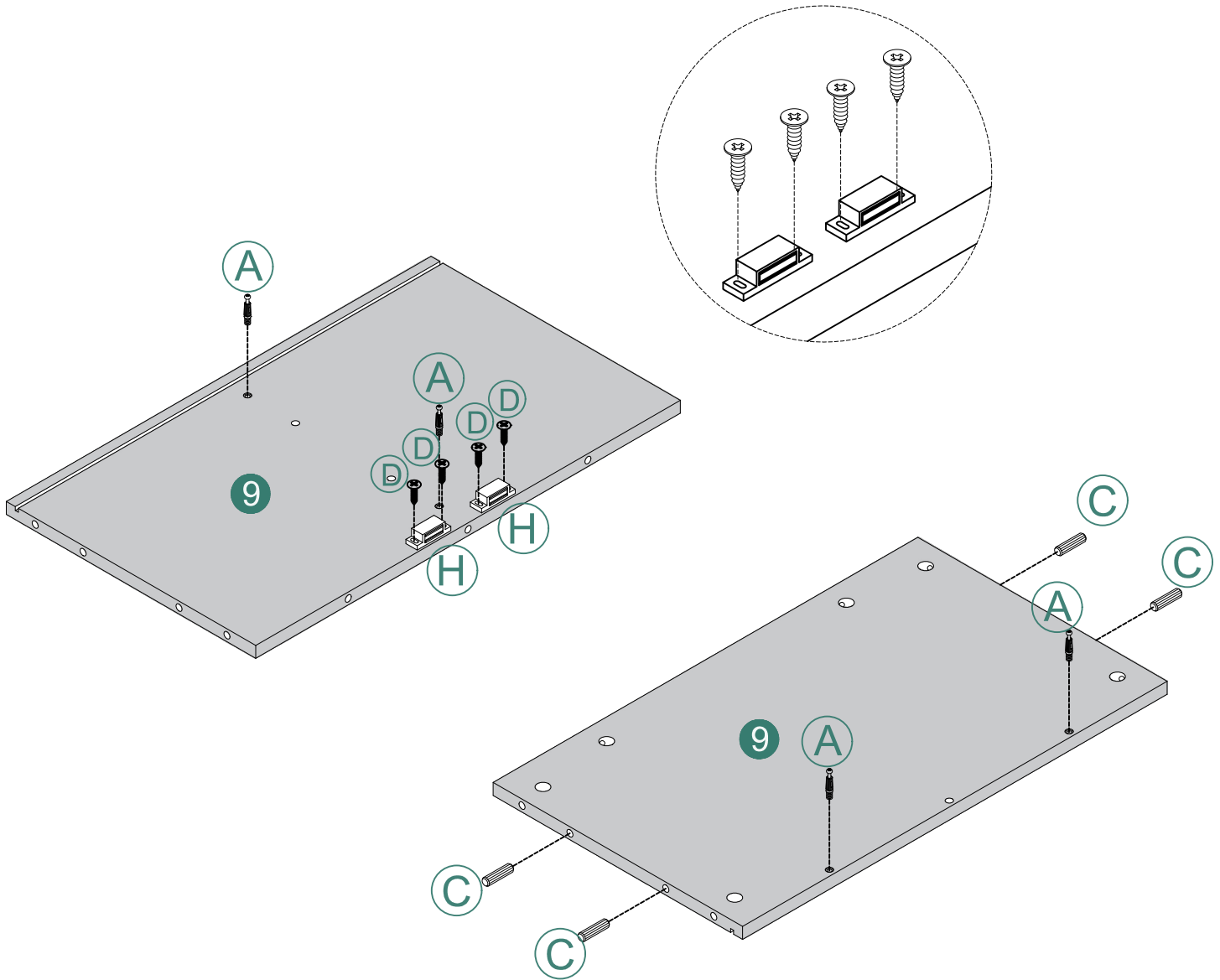

# 5

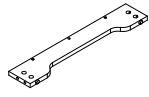

⑩1pc

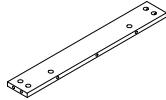

⑪1pc

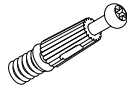

Ⓐ2pcs



Ⓑ4pcs

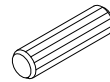

Ⓒ2pcs

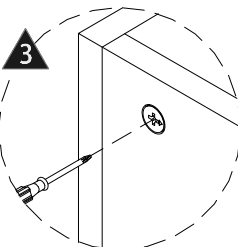
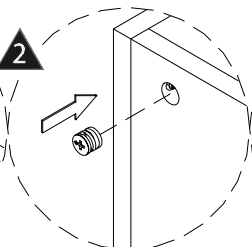
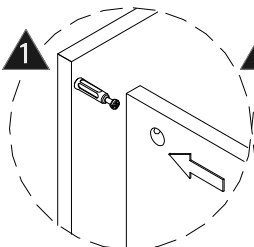
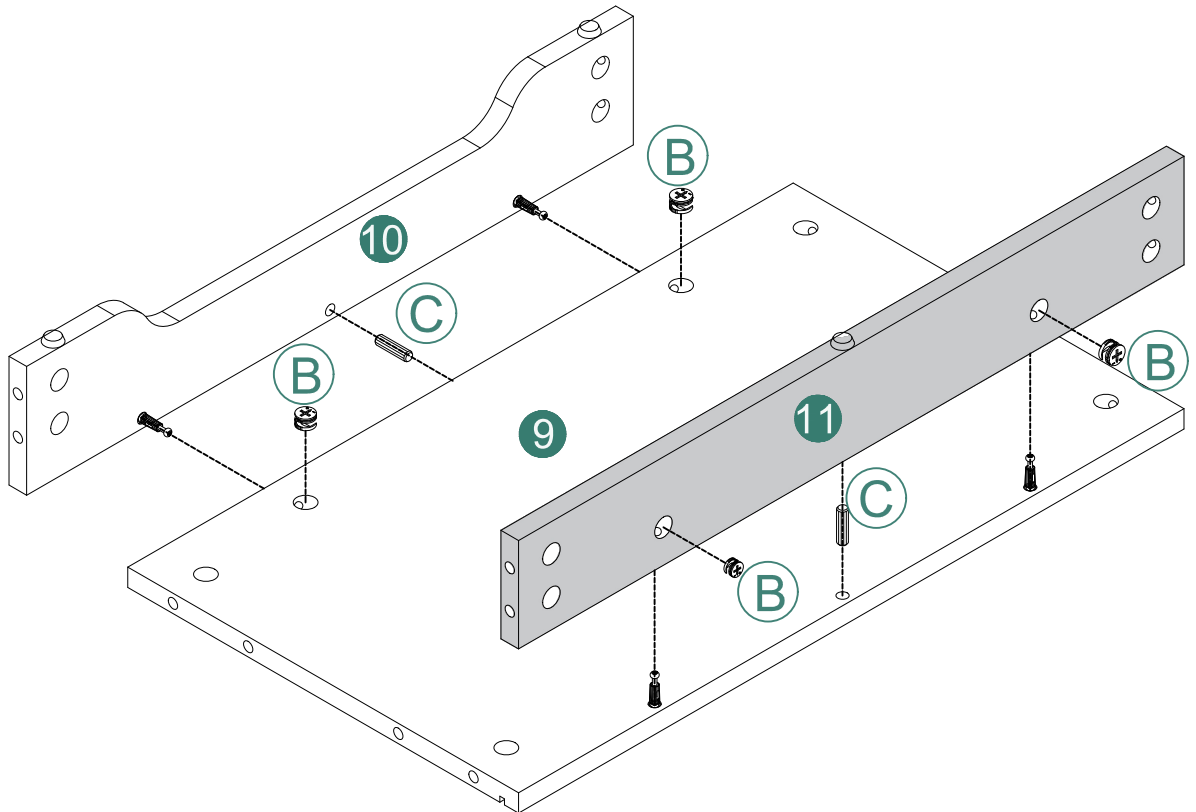
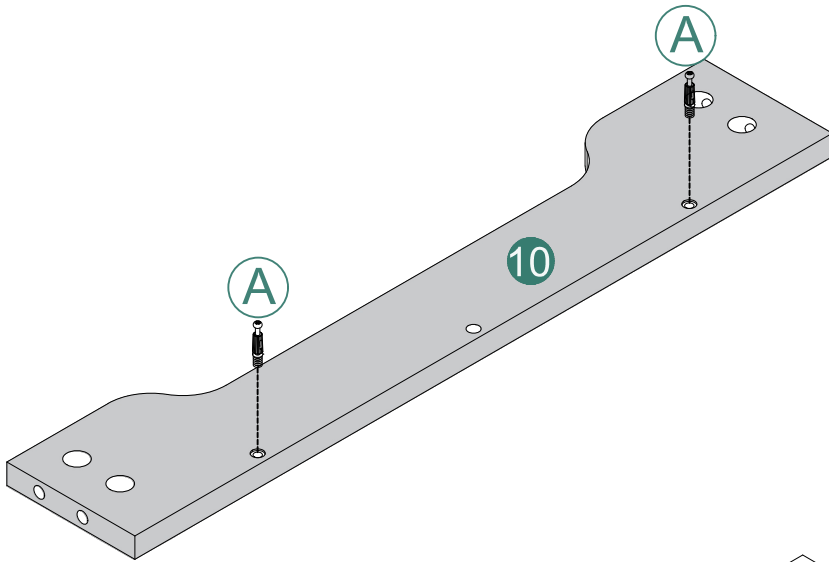

6



(B) 2pcs

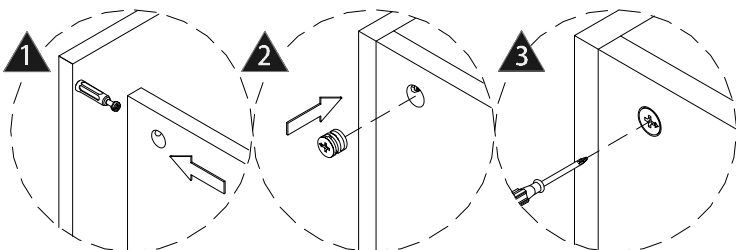
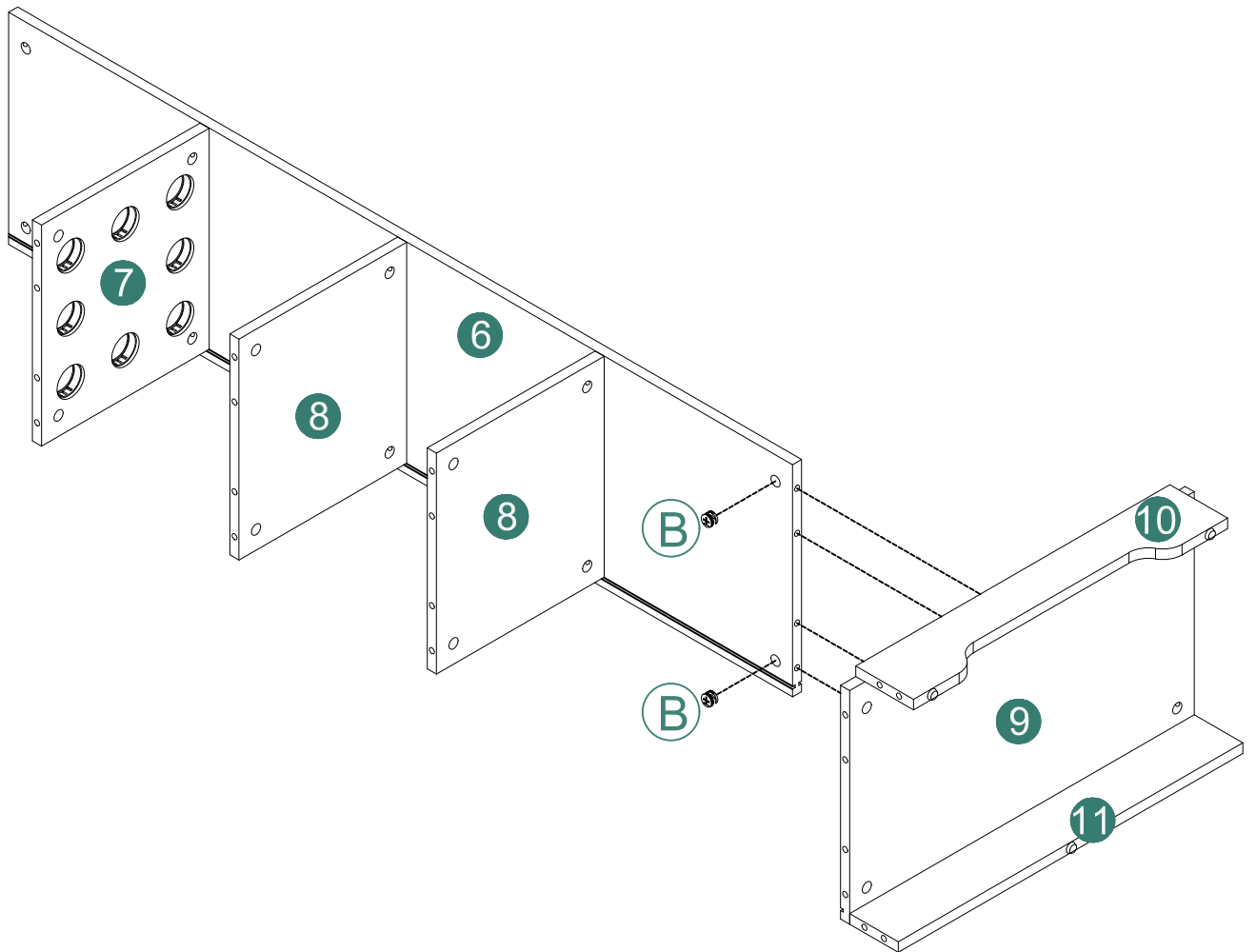

# 7

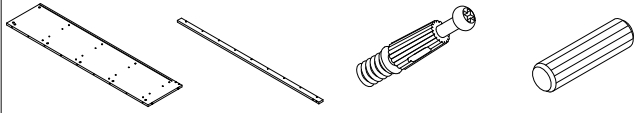

②1pc ③1pc (A)17pcs (C)2pcs

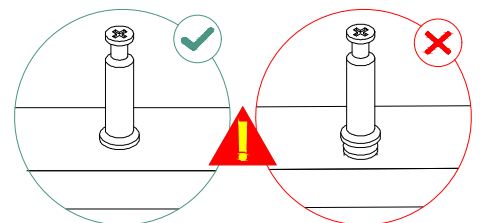
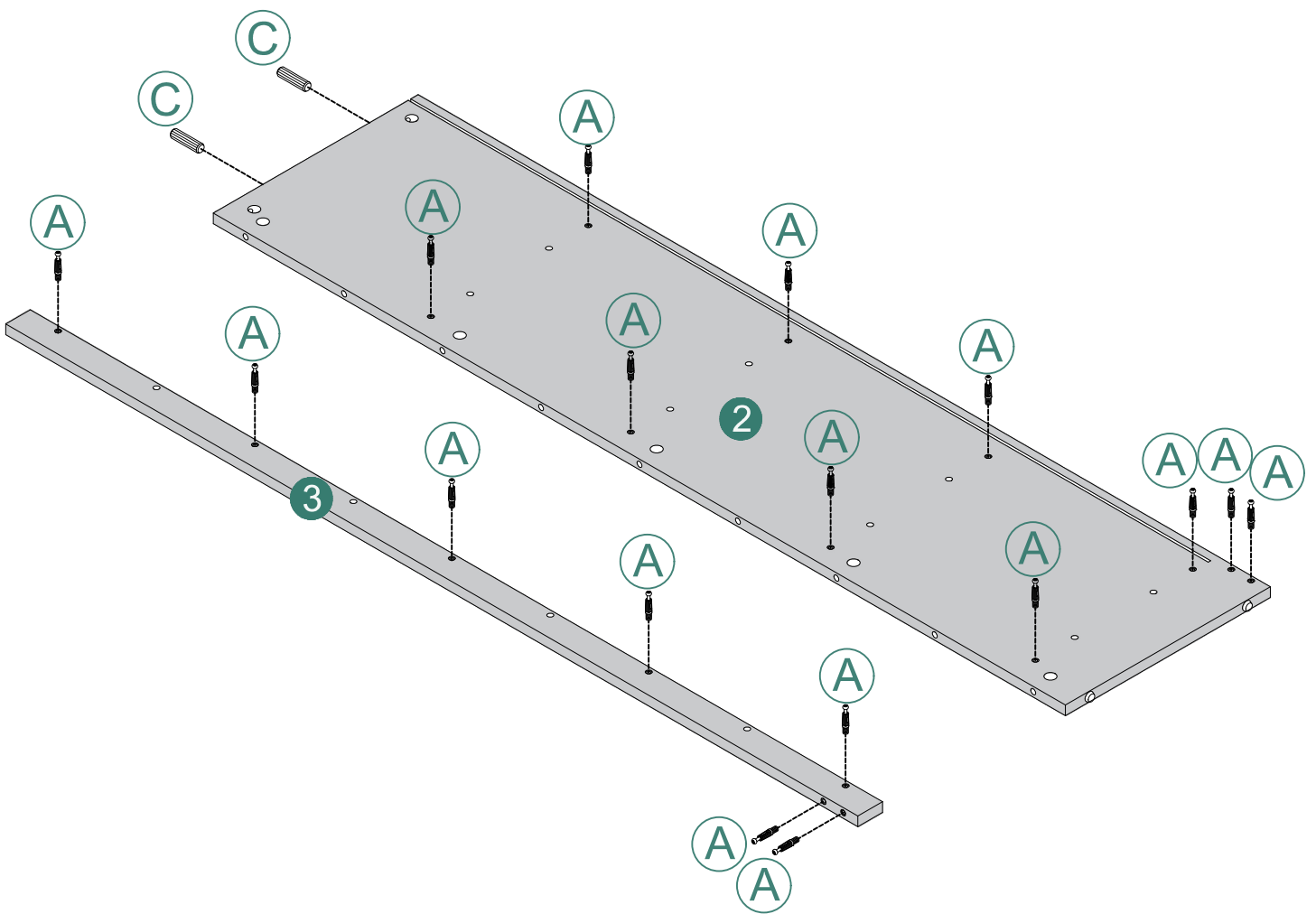

8



(B) 5pcs

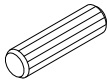

(C) 4pcs

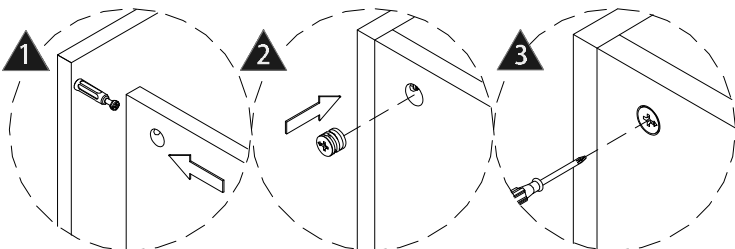
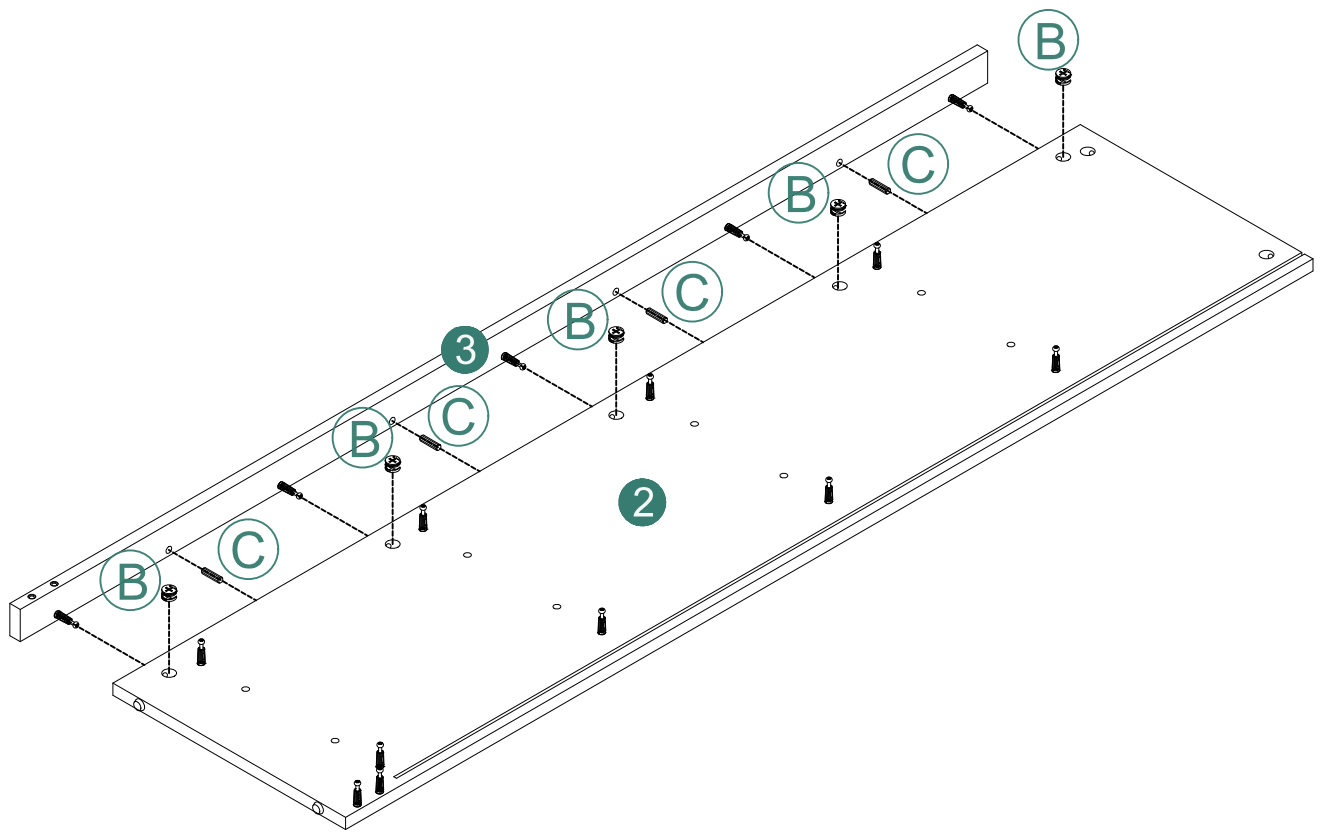



9

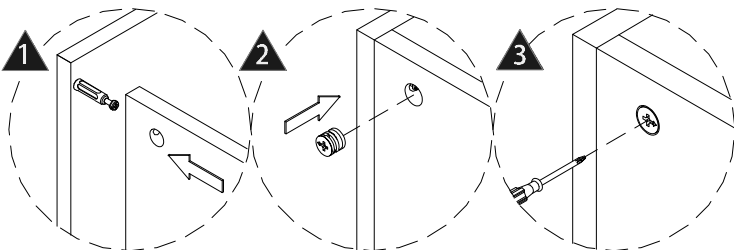
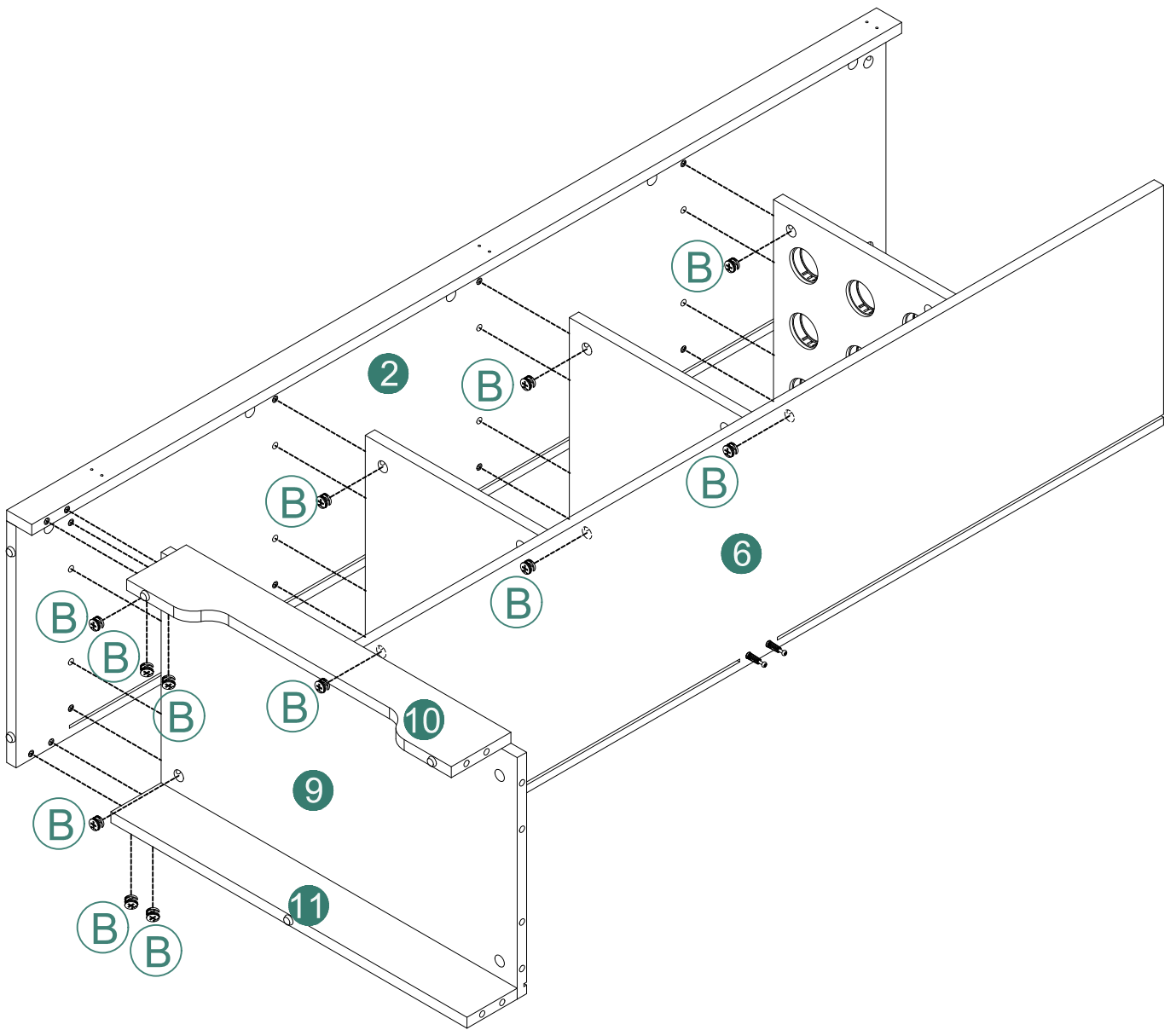

ⓑ12pcs

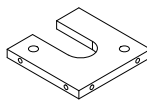
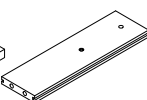
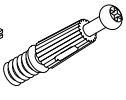

# 10

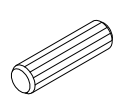
-  12 1pc
-  13 1pc
-  A 1pc
-  B 3pcs
-  C 2pcs

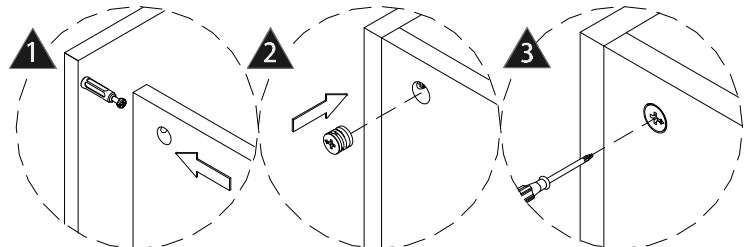
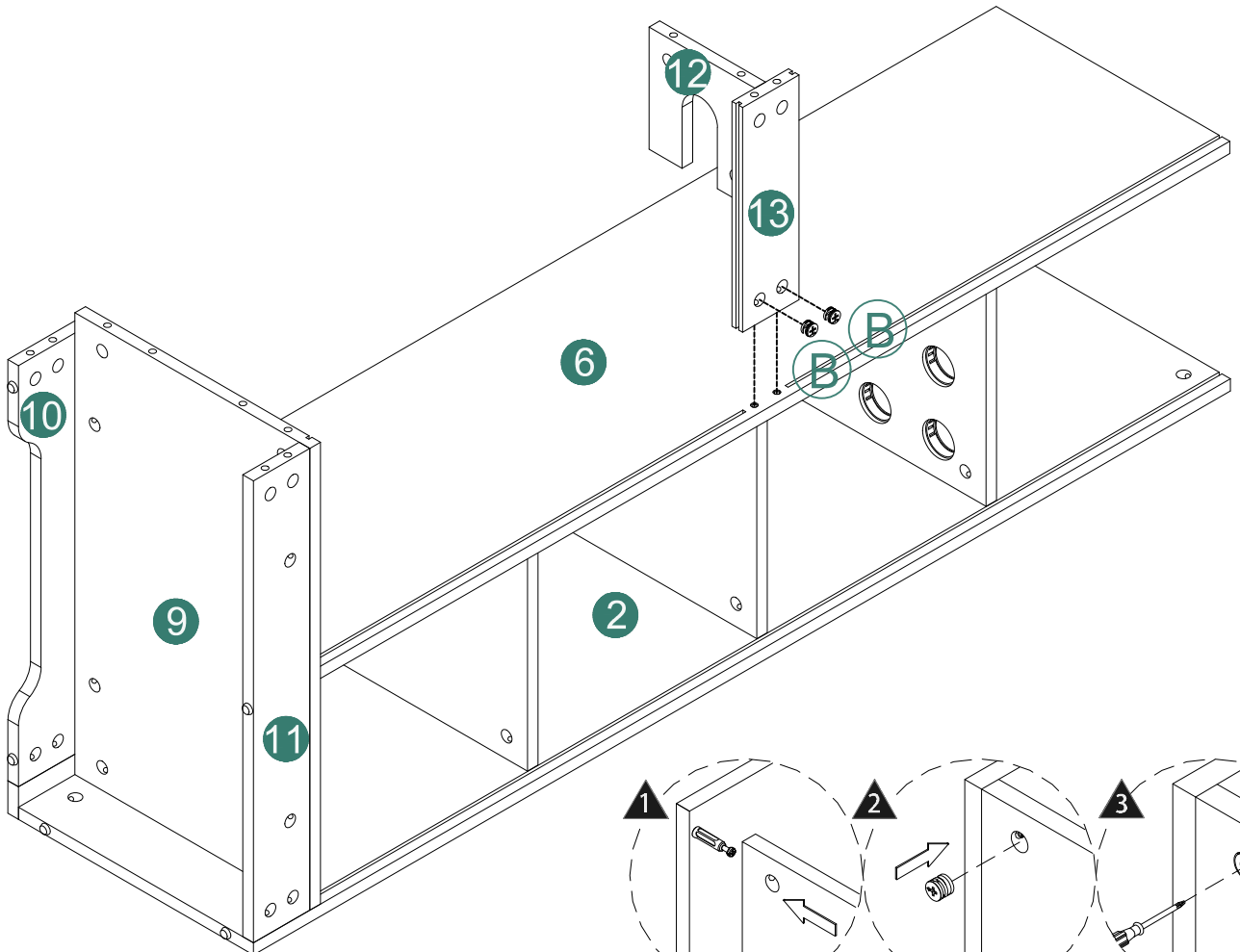
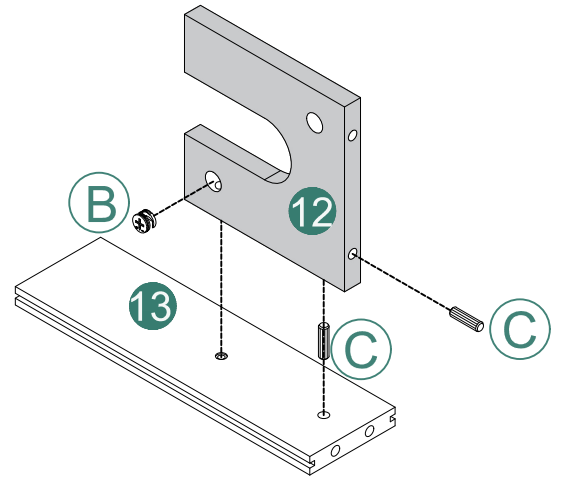
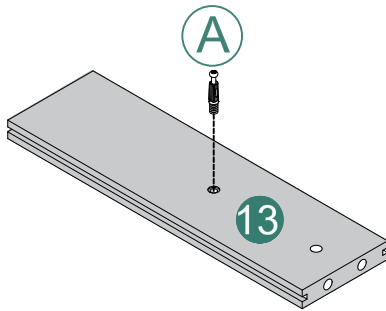
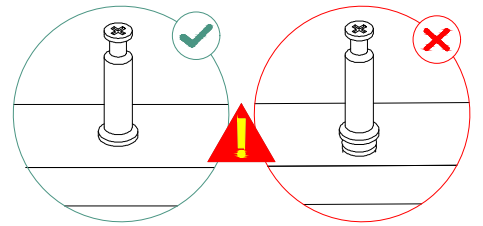

11

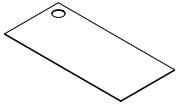

141pc

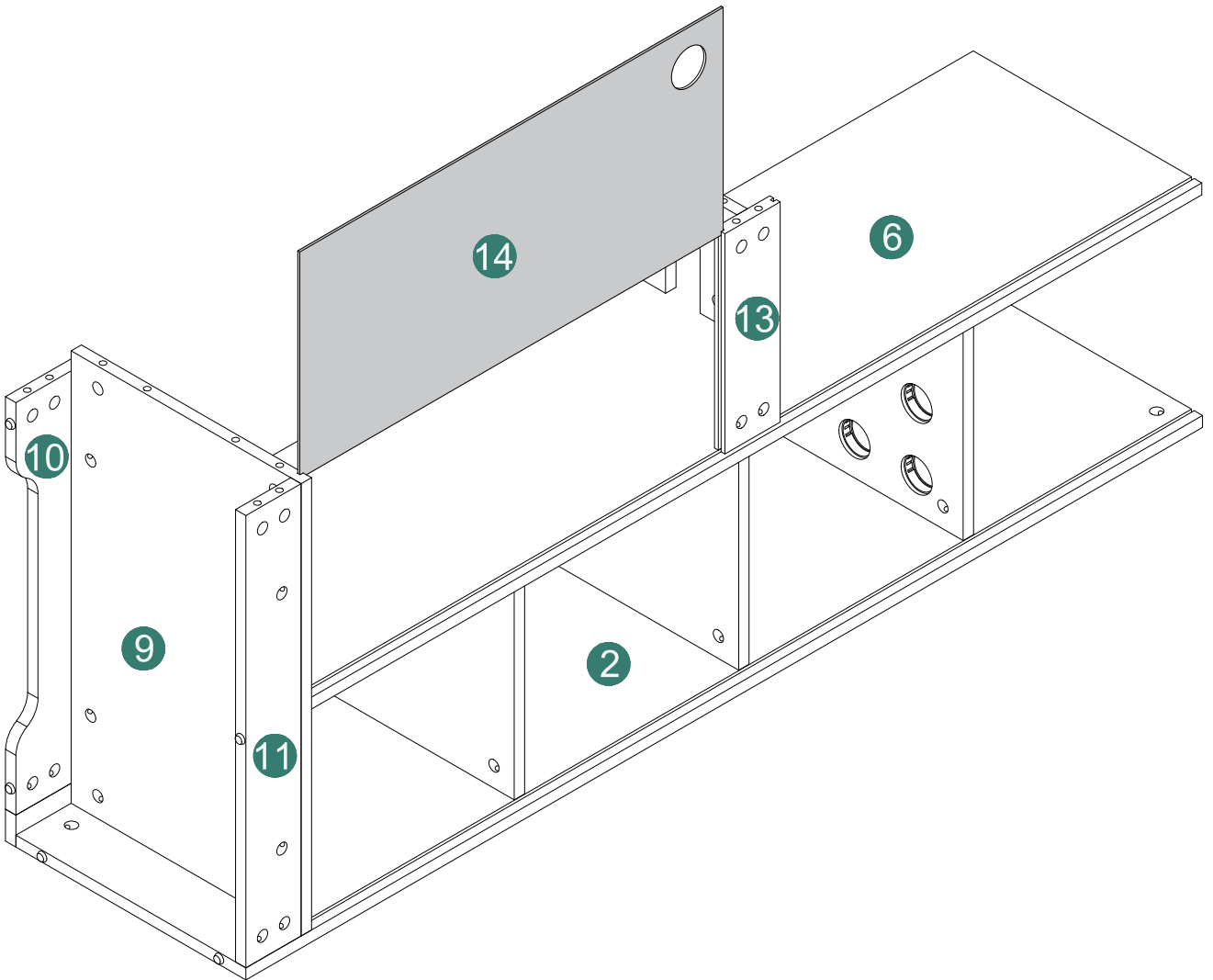

# 12

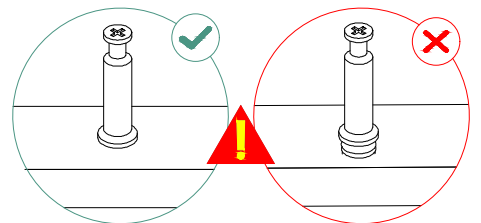
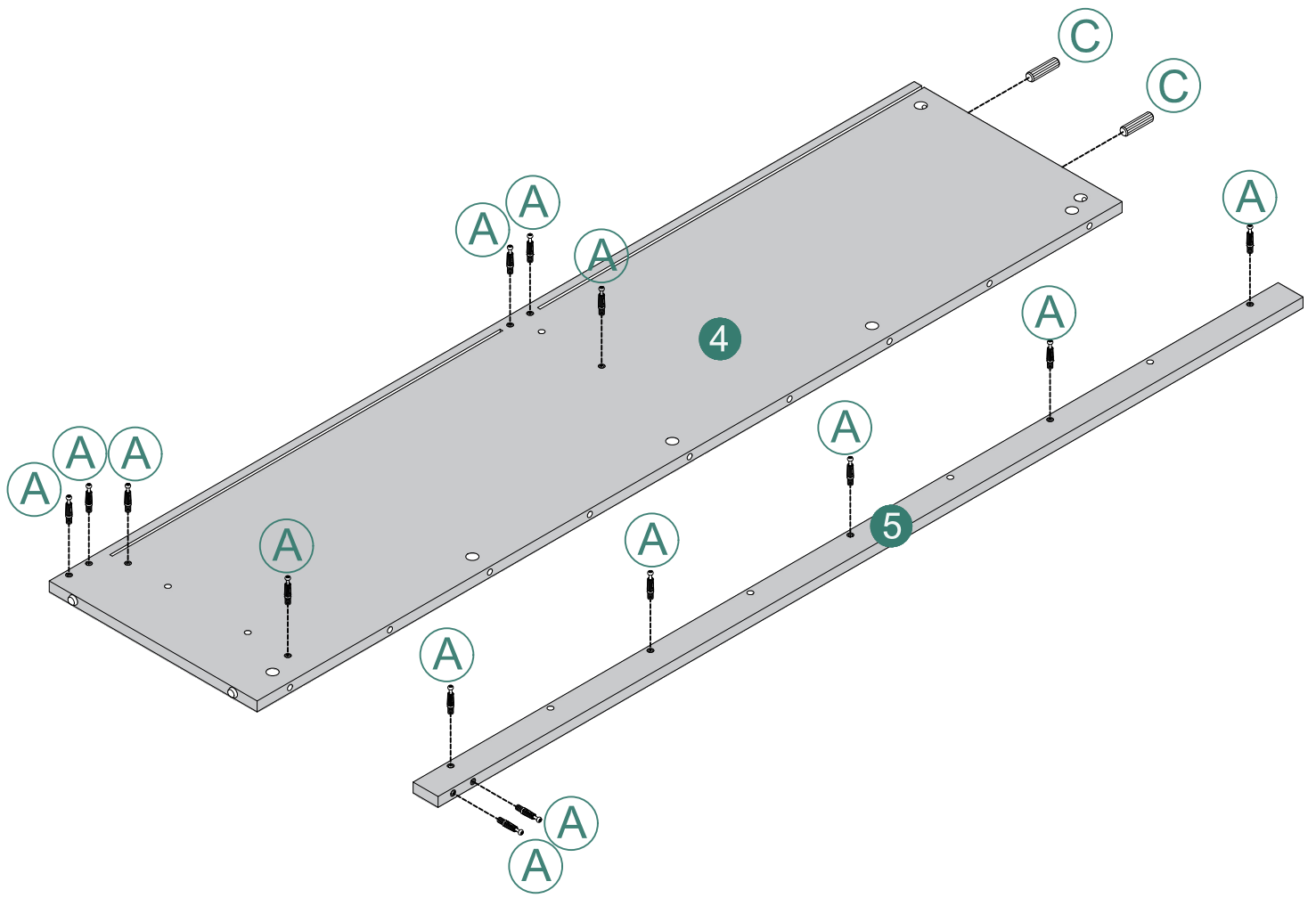
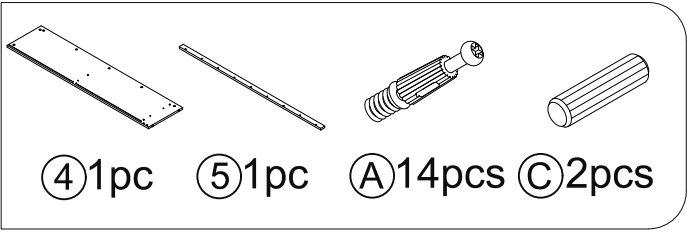

# 13

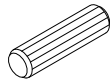

Ⓑ 5pcs

Ⓒ 4pcs

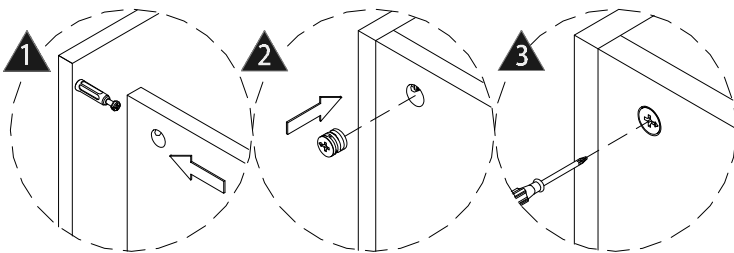
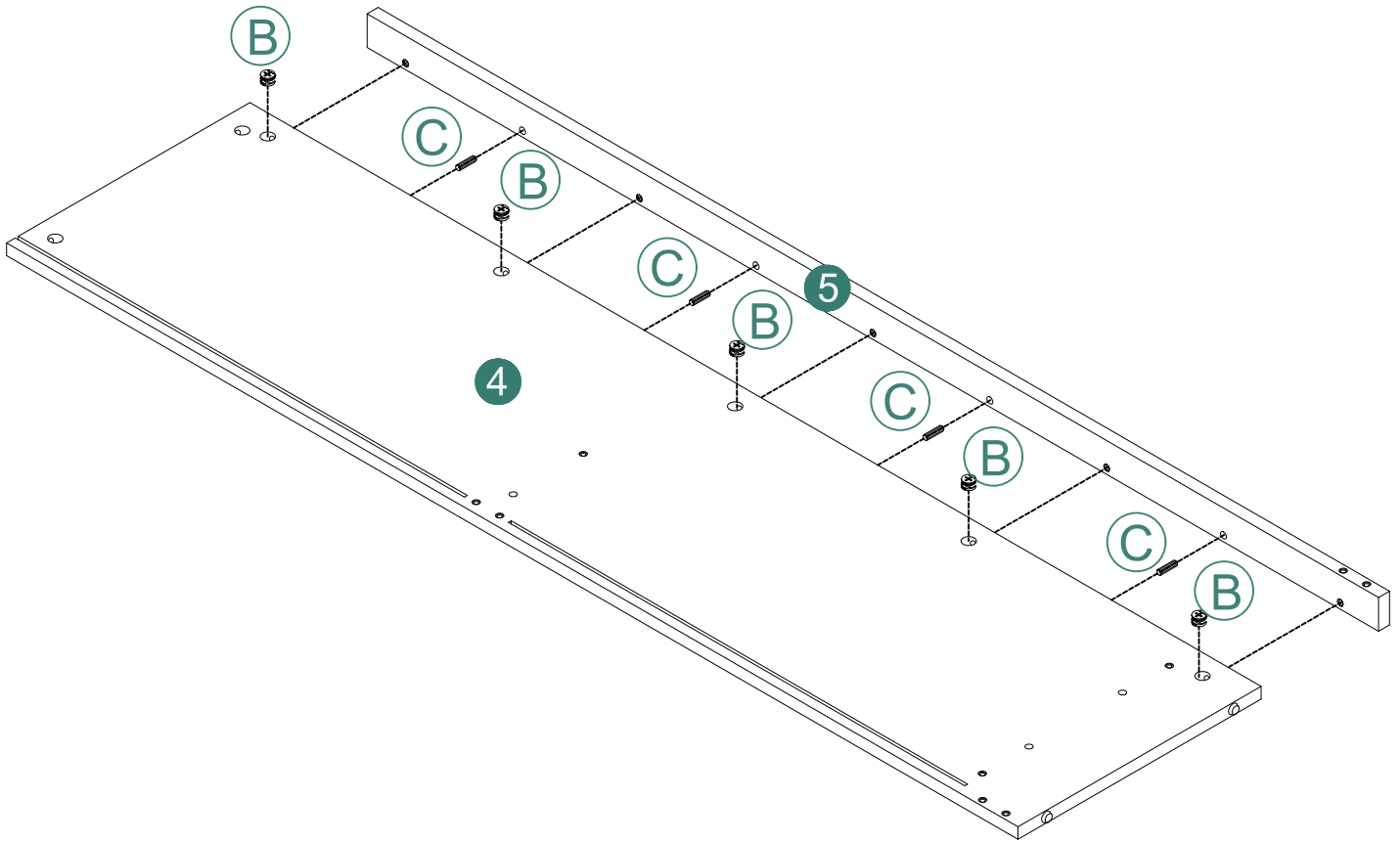

14



(B) 9pcs

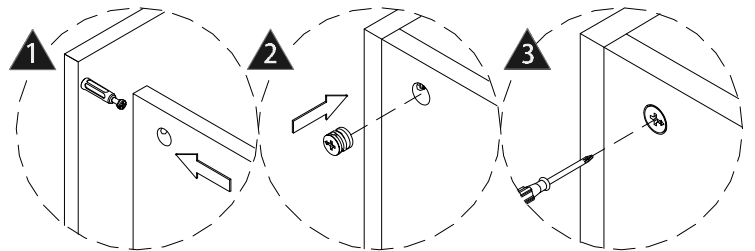
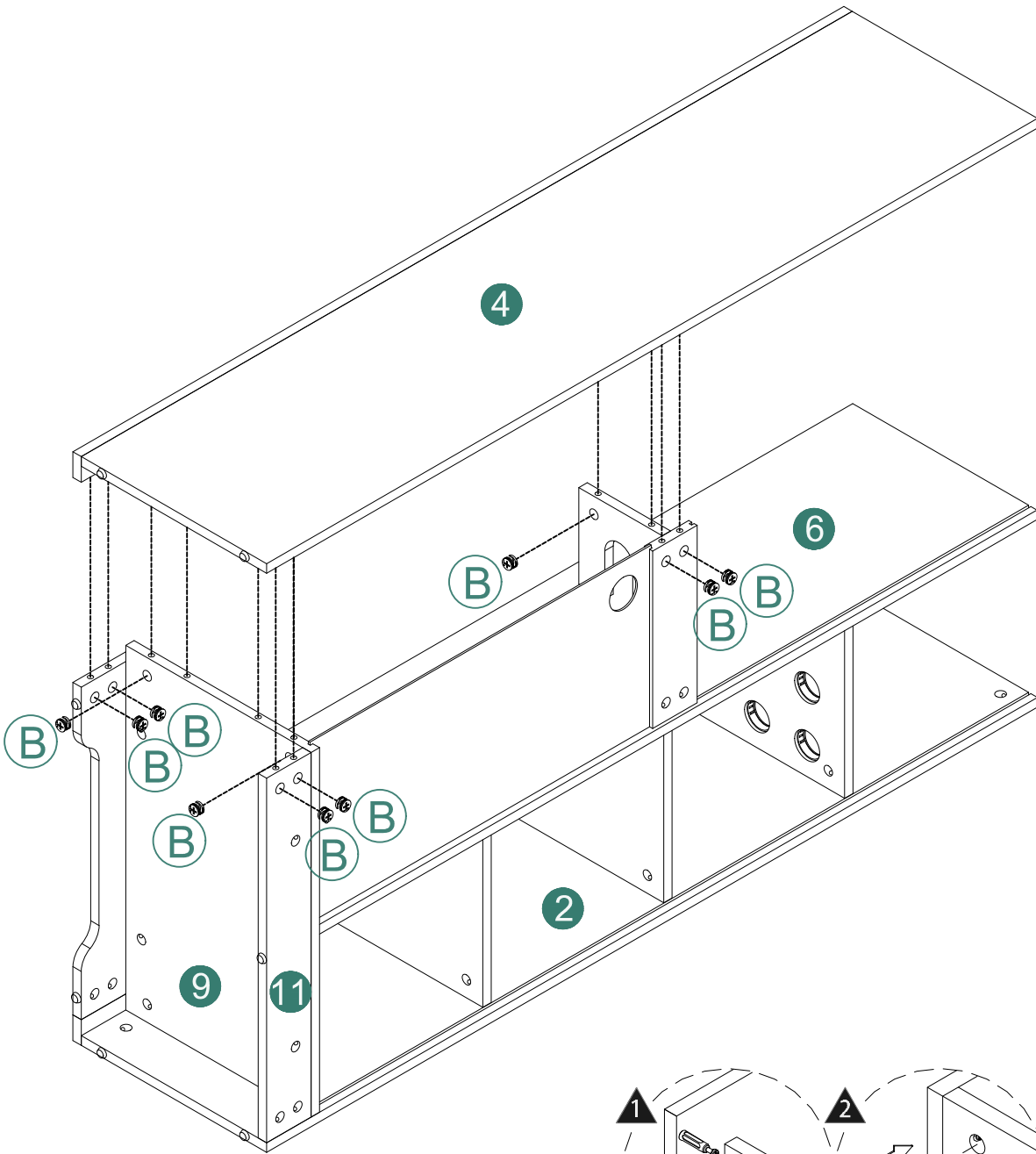

15

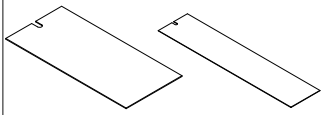

⑮1pc

⑯1pc

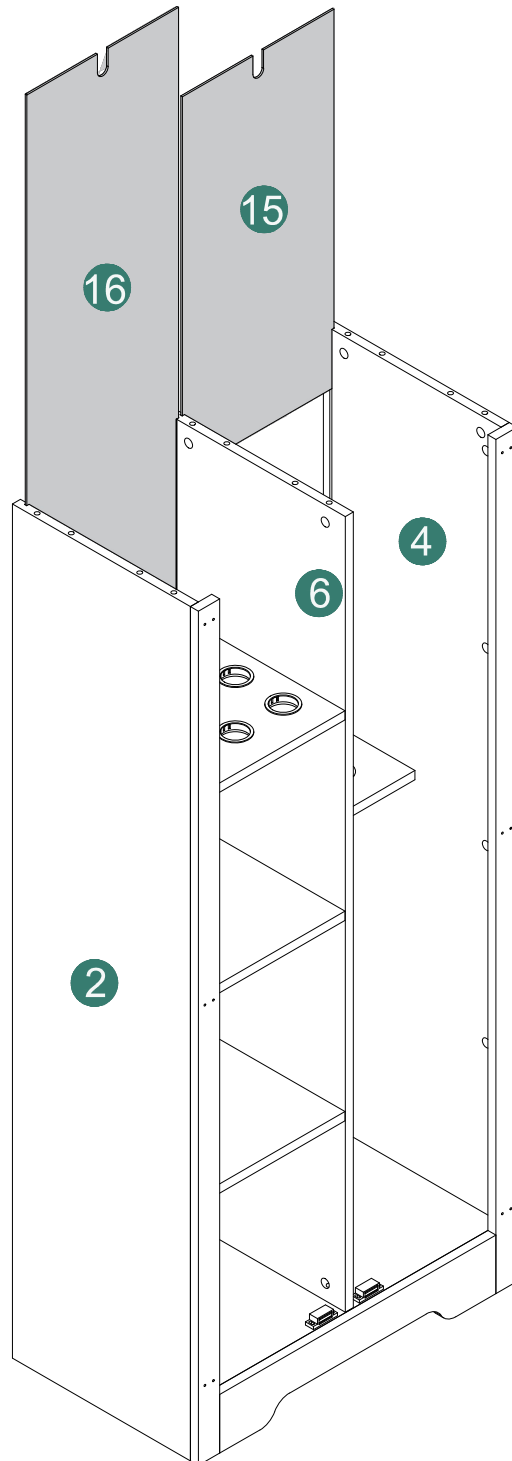

# 16

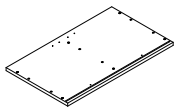

① 1pc

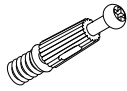

Ⓐ 6pcs



Ⓑ 6pcs



Ⓓ 4pcs

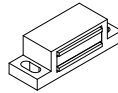

Ⓗ 2pcs



Ⓝ 2pcs



Ⓞ 2pcs

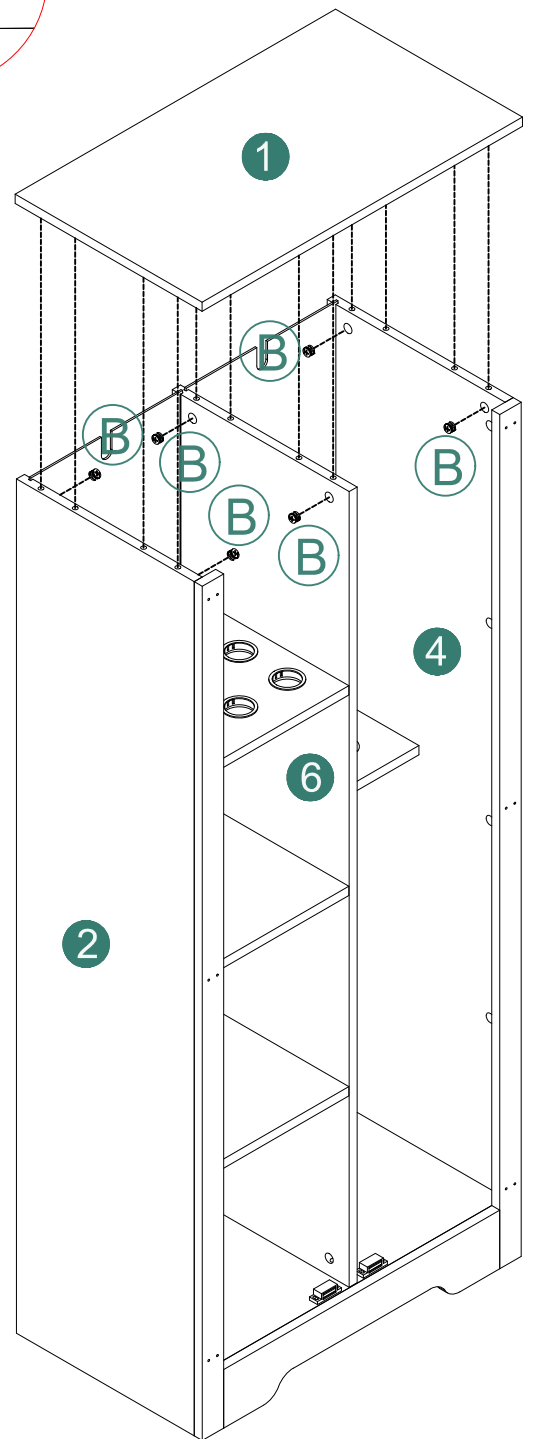
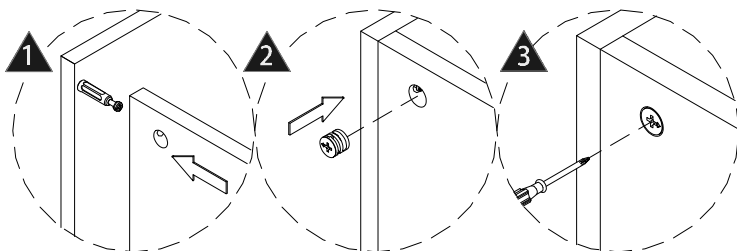
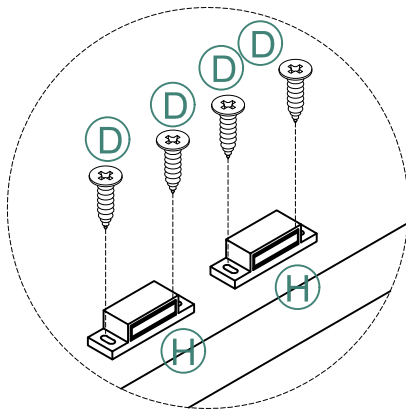
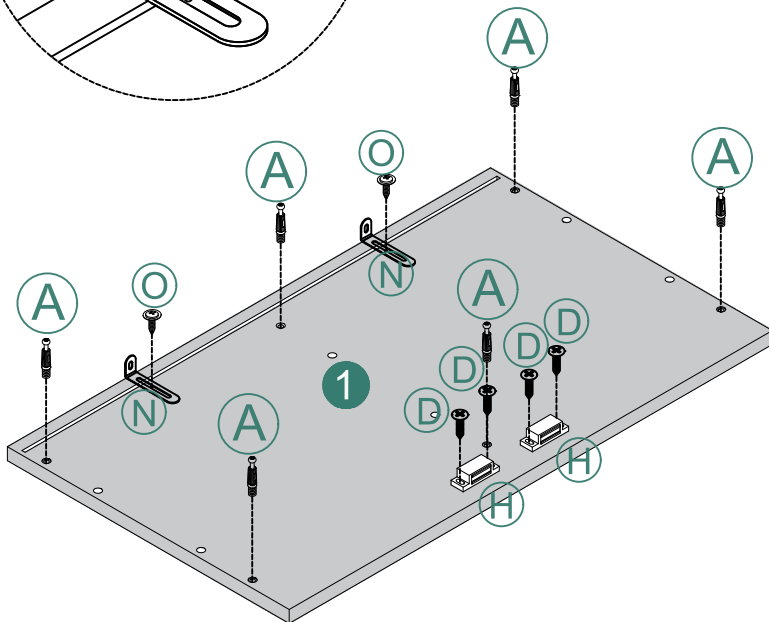
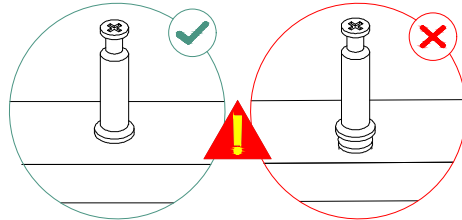
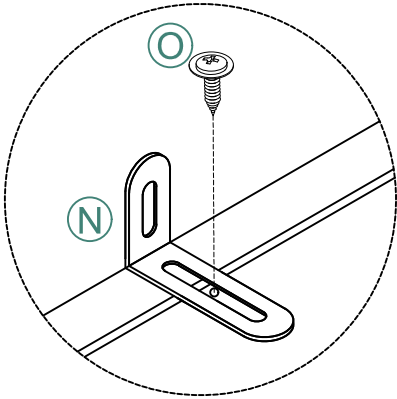

17



Ⓟ16pcs

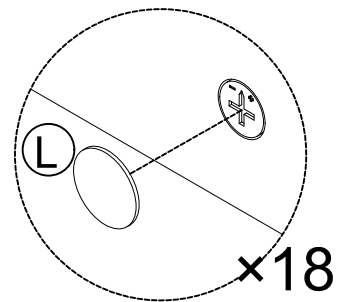
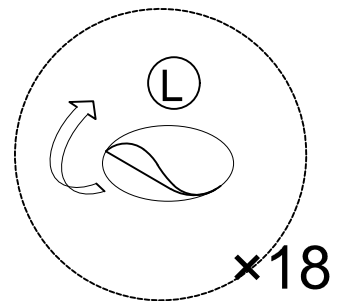
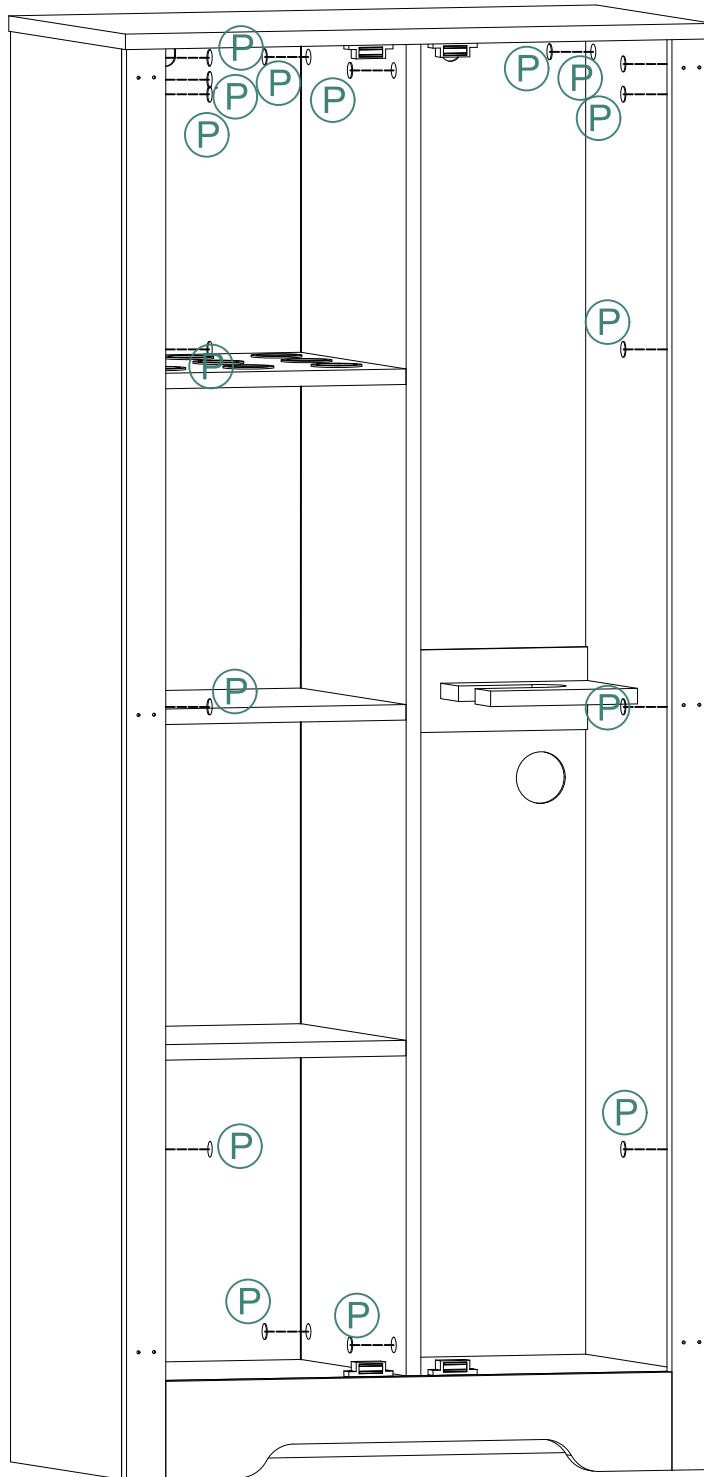

# 18

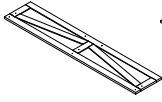

⑰1pc

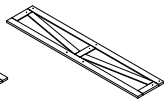

⑱1pc



ⓓ8pcs



ⓔ12pcs



ⓓ4pcs

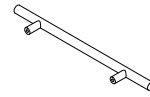

ⓙ2pcs

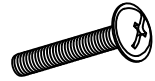

Ⓚ4pcs

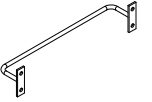

ⓠ3pcs

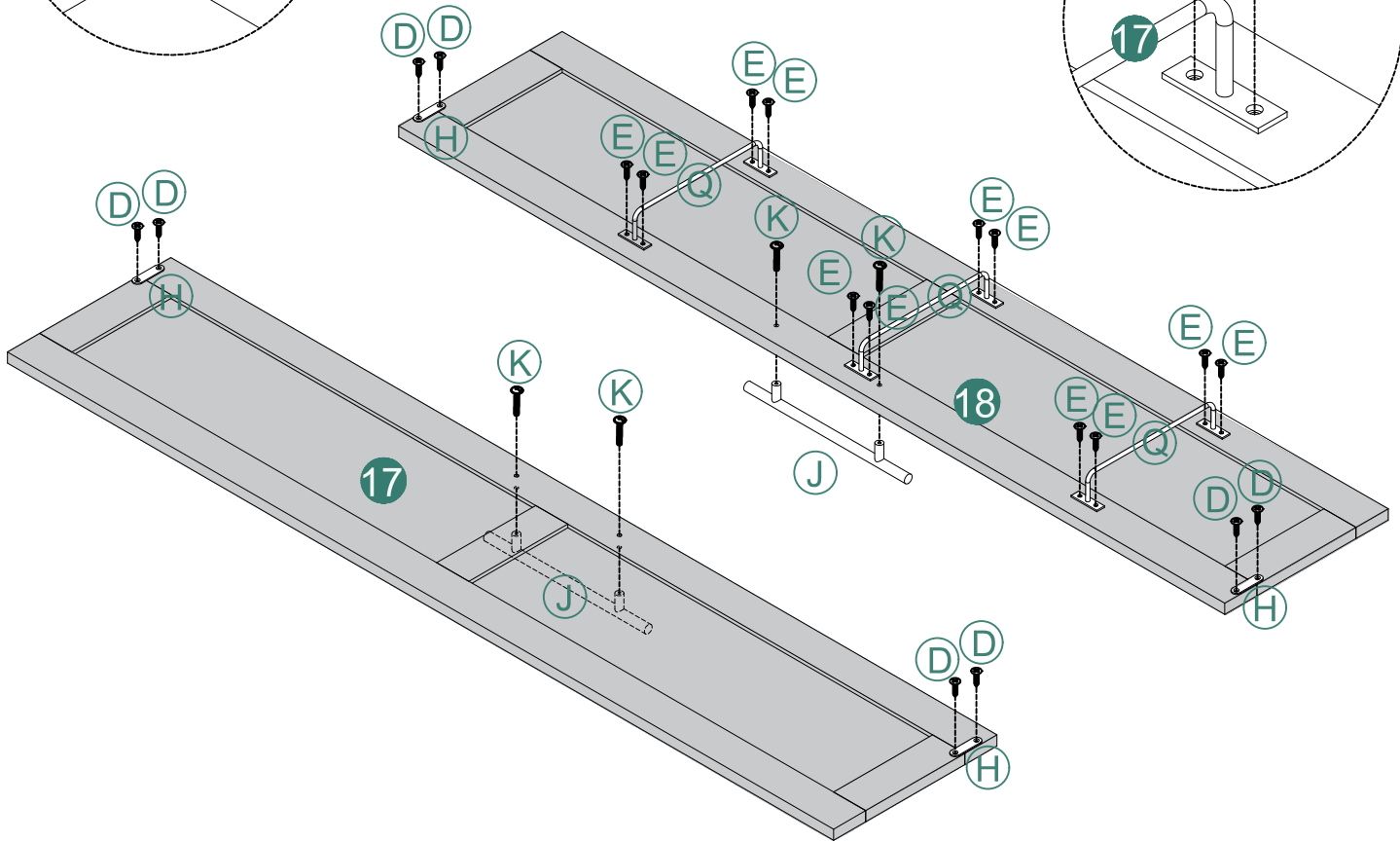
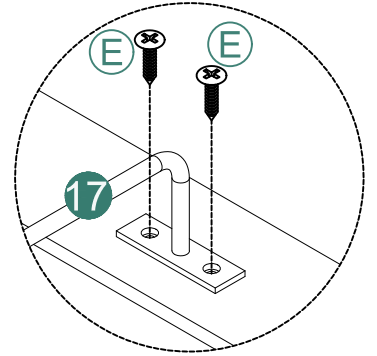
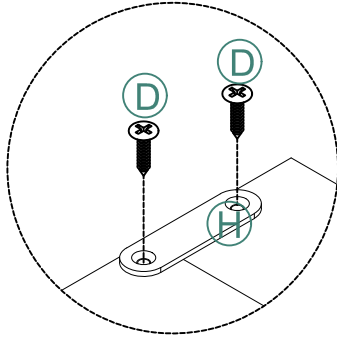

# 19

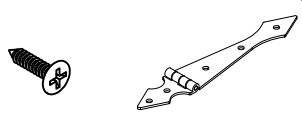

ⓓ18pcs ⓓ16pcs

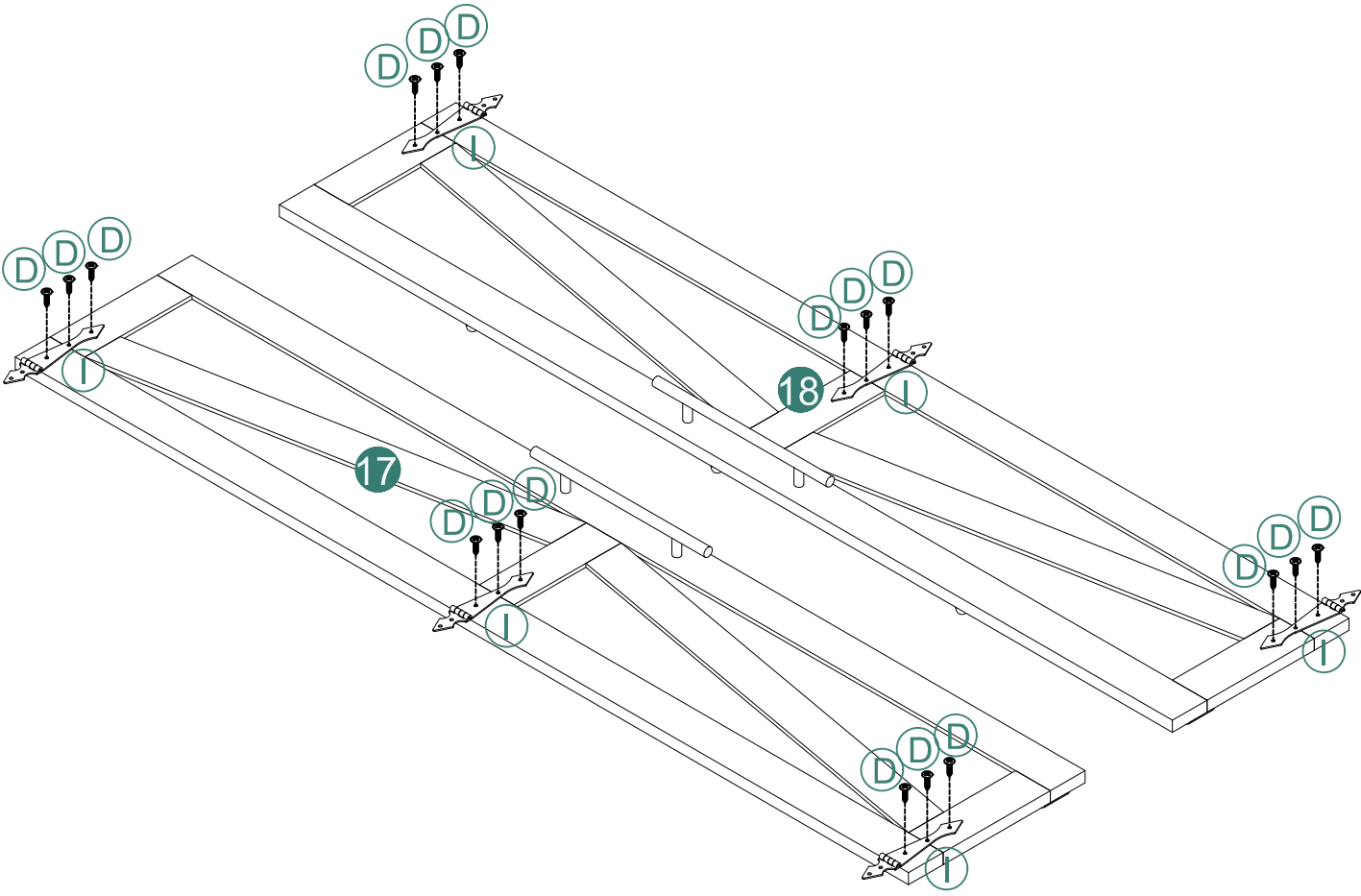

20



Ⓧ12pcs

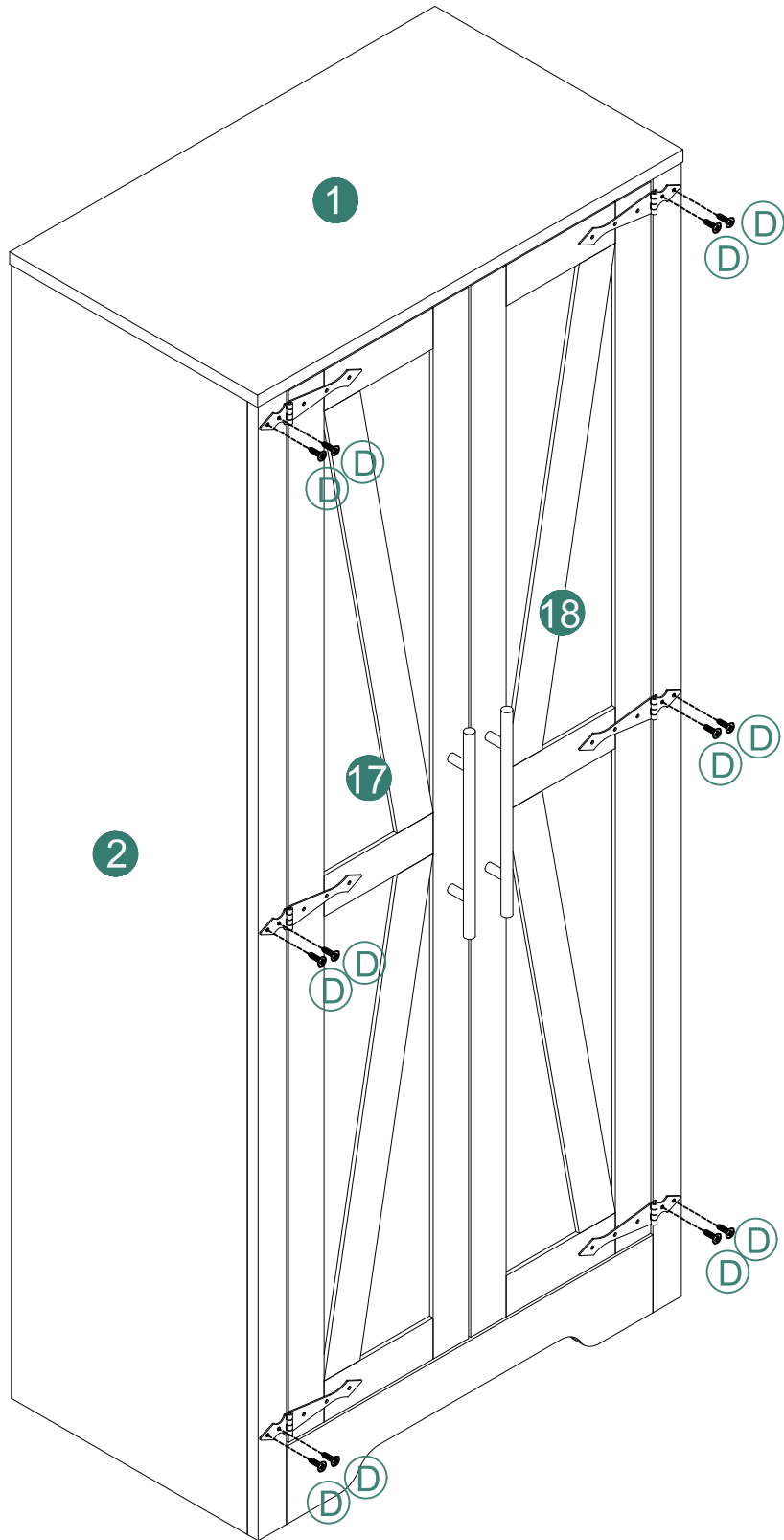

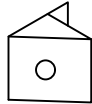

# 21

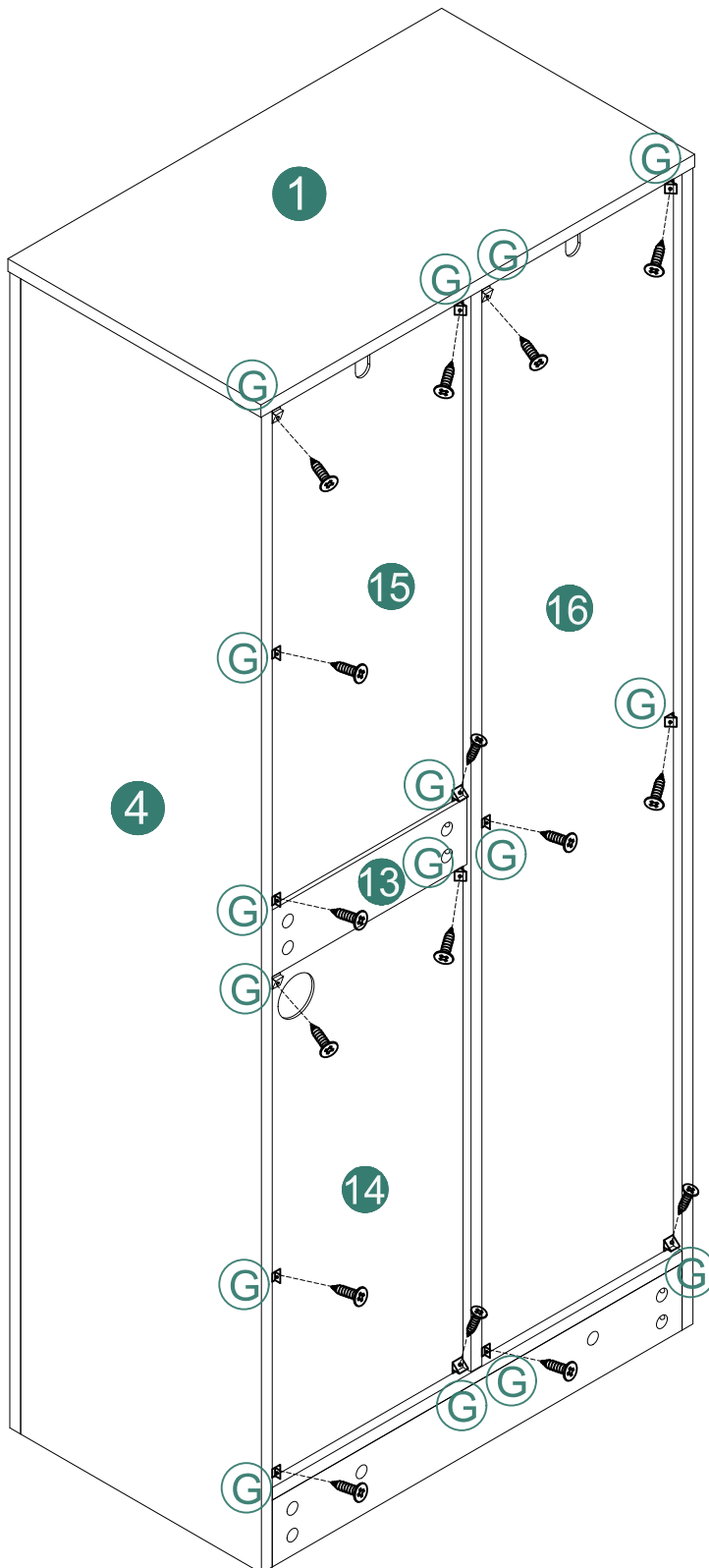
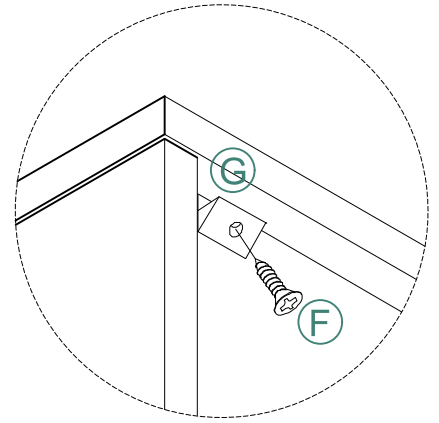

ⓕ16pcs ⓐ16pcs



# 22

-  (L) 2pcs
-  (M) 2pcs

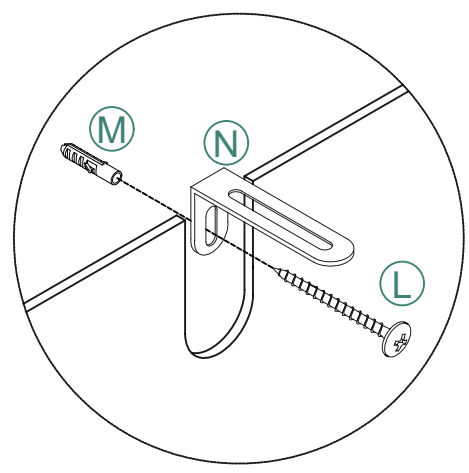

Wall



# HELP CENTR



**Inquiry**



**Assembly issue**



**Missing parts**

If you encounter any difficulties during assembly, please contact us.

Wenn Sie während der Montage auf Schwierigkeiten stoßen, kontaktieren Sie uns bitte.

Si vous rencontrez des difficultés lors du montage, veuillez nous contacter.

Se incontri difficoltà durante il montaggio, ti preghiamo di contattarci.

Si encuentras alguna dificultad durante el ensamblaje, por favor contáctanos.

# DISCLAIMER

Manufacturer and seller expressly disclaim any and all liability for personal injury, property damage or loss, whether direct, indirect, or incidental, resulting from the incorrect attachment, improper use, inadequate maintenance, unapproved modification, or neglect of this product.

Der Hersteller und Verkäufer lehnen ausdrücklich jegliche Haftung für Personenschäden, Sachschäden oder Verluste ab, egal ob direkt, indirekt oder zufällig, die durch falsche Anbringung, unsachgemäßen Gebrauch, unzureichende Wartung, nicht genehmigte Änderungen oder Vernachlässigung dieses Produkts entstehen.

El fabricante y vendedor renuncian expresamente a toda responsabilidad por lesiones personales, daños materiales o pérdidas, ya sean directos, indirectos o incidentales, derivados de la incorrecta colocación, uso inadecuado, mantenimiento insuficiente, modificación no aprobada o negligencia de este producto.

Il produttore e il venditore declinano espressamente ogni responsabilità per lesioni personali, danni materiali o perdite, dirette, indirette o incidentali, derivanti dall'errato fissaggio, uso improprio, manutenzione inadeguata, modifica non autorizzata o negligenza di questo prodotto.

Le fabricant et le vendeur déclinent expressément toute responsabilité en cas de blessures corporelles, de dommages matériels ou de pertes, qu'ils soient directs, indirects ou accessoires, résultant de la fixation incorrecte, de l'utilisation inappropriée, de l'entretien insuffisant, de la modification non approuvée ou de la négligence de ce produit.